

# User Guide

NCR PX10/PX15 POS (7746)



**NCR VOYIX**

BCC5-0000-5287

Issue H

---

The product described in this document is a licensed product of NCR Corporation.

NCR is a registered trademark of NCR Corporation. NCR POS is a trademark of NCR Corporation in the United States and/or other countries. Other product names mentioned in this publication may be trademarks or registered trademarks of their respective companies and are hereby acknowledged.

The terms HDMI and HDMI High-Definition Multimedia Interface, and the HDMI Logo are trademarks or registered trademarks of HDMI Licensing LLC in the United States and other countries.

Where creation of derivative works, modifications or copies of this NCR copyrighted documentation is permitted under the terms and conditions of an agreement you have with NCR, NCR's copyright notice must be included.

It is the policy of NCR Corporation (NCR) to improve products as new technology, components, software, and firmware become available. NCR, therefore, reserves the right to change specifications without prior notice.

All features, functions, and operations described herein may not be marketed by NCR in all parts of the world. In some instances, photographs are of equipment prototypes. Therefore, before using this document, consult with your NCR representative or NCR office for information that is applicable and current.

Copyright © 2018–2024

By NCR Corporation

Global Headquarters

864 Spring St NW

Atlanta, GA 30308

U.S.A.

All Rights Reserved

---

# Preface

## Audience

This book is written for hardware installer/service personnel, system integrators, and field engineers.

**Notice:** This document is NCR proprietary information and is not to be disclosed or reproduced without consent.

## Safety Requirements

The NCR PX10/PX15 POS (7746) conforms to all applicable legal requirements. To view the compliance statements see [HSR POS Safety and Regulatory Statements](#) (BCC5-0000-5069) and [RealPOS Terminals Safety and Regulatory Information](#) (B005-0000-1589).



**Caution:** The on/off switch is a logic switch only. The AC line voltage primaries are live at all times when the power cord is connected. Therefore, disconnect the AC power cord before opening the unit to install features or service this terminal.

### ***Lithium Battery Warning***



**Warning:** Danger of explosion if battery is incorrectly replaced. Replace only with the same or equivalent type as recommended by the manufacturer. Discard used batteries according to the manufacturer's instructions.



**Attention:** Il y a danger d'explosion s'il y a remplacement incorrect de la batterie. Remplacer uniquement avec une batterie du même type ou d'un type recommandé par le constructeur. Mettre au rebut les batteries usagées conformément aux instructions du fabricant.

### ***Battery Disposal (Switzerland)***

Refer to Annex 4.10 of SR814.013 for battery disposal.

### ***IT Power System***

This product is suitable for connection to an IT power system with a phase-to-phase voltage not exceeding 240 V.

### ***Peripheral Usage***

This terminal should only be used with peripheral devices that are certified by the appropriate safety agency for the country of installation (UL, CSA, TUV, VDE) or those which are recommended by NCR Corporation.



**Warning: DO NOT connect or disconnect the transaction printer while the terminal is connected to AC power. This can result in system or printer damage.**



**Warning: DO NOT connect or disconnect any serial peripherals while the terminal is connected to AC power. This can result in system or printer damage.**

### ***Grounding Instructions***

In the event of a malfunction or breakdown, grounding provides a path of least resistance for electric current to reduce the risk of electric shock. This product is equipped with an electric cord having an equipment-grounding conductor and a grounding plug. The plug must be plugged into a matching outlet that is properly installed and grounded in accordance with all local codes and ordinances. Do not modify the plug provided – if it will not fit the outlet, have the proper outlet installed by a qualified electrician. Improper connection of the equipment-grounding conductor can result in a risk of electric shock.

The conductor with insulation having an outer surface that is green with or without yellow stripes is the equipment-grounding conductor.

If repair or replacement of the electric cord or plug is necessary, do not connect the equipment-grounding conductor to a live terminal. Check with a qualified electrician or service personnel if the grounding instructions are not completely understood, or if you are in doubt as to whether the product is properly grounded.

Use only 3-wire extension cords that have 3-prong grounding plugs and 3-pole receptacles that accept the product's plug. **Repair or replace damaged or worn cords immediately.**

## Warranty

Warranty terms vary by region and country.

All parts of this product that are subject to normal wear and tear are not included in the warranty. In general, damages due to the following are not covered by the warranty.

- Improper or insufficient maintenance
- Improper use or unauthorized modifications of the product.
- Inadequate location or surroundings. Site installation must conform to guidelines listed in the *NCR PX10/PX15 POS (7746) Site Preparation Guide* (BCC-0000-5288) and the [NCR Workstation and Peripheral AC Wiring Guide](#) (BST0-2115-53).

For detailed warranty arrangements please consult your contract documents.



---

# Table of Contents

## **Chapter 1: Product Overview**

Features .....	2
Mounting Configurations .....	4
With 7746 Stand .....	4
With 7746 Stand with Battery .....	4
With XL7 Customer Display .....	5
With 2x20 Customer Display .....	5
I/O Expansion .....	6
I/O Expansion Box (7746-F122) .....	6
I/O Expansion Integrated Stand (7746-F123) .....	7
Scanner .....	7
Programming the Scanner .....	7
Specifications .....	8
Operator Controls .....	10
Power Button .....	10
Recovery Tool Button .....	11
Label Locations .....	12

## **Chapter 2: Hardware Installation**

Installation Restrictions .....	13
Installation Notes .....	14
Ergonomic Workplace .....	16
Installing the Terminal .....	17
Connecting AC Power .....	17
Connecting to a Network .....	19
Starting Up the Terminal .....	20

---

Installing the Cash Drawer .....	21
Second Cash Drawer Cable Connection .....	21
Terminal I/O .....	22
Power In .....	23
LAN .....	23
LAN Cable .....	23
USB Type C Port .....	25
USB 3.0 Ports .....	26
RJ45 Serial Port .....	27
RJ45 Adapter Cables .....	27
RJ12 Cash Drawer Port .....	31
Cash Drawer Cables .....	31
SIM Card Reader .....	33

### **Chapter 3: Disk Image Backup and Recovery Tool**

Introduction .....	35
Running the Recovery Tool .....	36
Starting the Recovery Tool .....	36
Main Screen .....	37
Check and Repair Disk .....	37
Save or Load Image .....	37
Change Settings .....	37
Shutdown or Reboot .....	37
System Information .....	37
Save or Load Image .....	38
Saving an Image .....	39
Loading An Image .....	42
Change Settings .....	47
Change Network Settings .....	48
Change Password .....	49

---

Replace Recovery Image .....	50
Change Language .....	51
Creating a Disk Image .....	52

#### **Chapter 4: BIOS Setup**

Entering Setup .....	53
How to Select Menu Options .....	53
Restoring Factory Settings .....	53

#### **Chapter 5: BIOS Updating Procedure**

Introduction .....	55
Prerequisites .....	55
USB Memory Key update prerequisites .....	55
Windows Flash Executable update prerequisites .....	55
SPI/BIOS Updating Procedures .....	56
Using the bootable USB Memory key .....	56
Using the Window Flash executable .....	56
Using the Unattended Windows Flash method .....	57

#### **Chapter 6: Terminal Imaging**

Initial Terminal Imaging .....	59
Imaging Procedure .....	59

#### **Chapter 7: Cleaning**

Cleaning the Touchscreen .....	61
Cleaning the Cabinet .....	62



## Revision Record

Issue	Date	Remarks
A	June 2018	First Issue
B	Sept 2018	Updated BIOS Default Values section
C	May 2019	Updated BIOS Setup and BIOS Updating Procedure chapters Release 1.1 and 2.0
D	Aug 2019	Added F457
E	Mar 2020	Added Cleaning chapter
F	Oct 2020	Release 2.1
G	Nov 2020	Added "Programming the Scanner" section
H	Nov 2024	Removed OBF and Returning Defective Hardware for Service

---

## Chapter 1: Product Overview

---



CCP-73916

The NCR 7746 terminal, with the option of a 10.1" or a 15.6" Wide Full HD touchscreen, is a compact, tablet-like terminal that is purpose-built with full feature options and lifecycle support.

The all-in-one terminal utilizes a next generation Intel® Celeron™ Processor N3350 (Dual core, up to 2.4 GHz). The highly efficient processor offers great performance, but with lower power consumption for a more reliable design.

Every business is different, which is why the NCR 7746 terminal is purpose-built to be one of the most versatile form factors on the market. Optional features include magnetic stripe reader, scanner, Wi-Fi capability, customer-facing display, and battery backup.

## Features

Feature	Description
<b>Operator Display</b>	<ul style="list-style-type: none"> <li>• 10.1" Wide Full HD LCD with Projective Capacitive (PCap) Touch</li> <li>• 15.6" LCD, PCAP Touch</li> </ul>
<b>Processor</b>	Intel CPU – Dual-core (N3350 2.4Ghz)
<b>Operating Systems</b>	<ul style="list-style-type: none"> <li>• Windows 10 IoT 64bit</li> <li>• Android (6.0)</li> </ul>
<b>Memory</b>	<ul style="list-style-type: none"> <li>• 4GB RAM (Standard)</li> <li>• 8GB RAM (Option)</li> </ul>
<b>Storage</b>	<ul style="list-style-type: none"> <li>• 32GB SSD (for Android only)</li> <li>• 64GB SSD (minimum for Windows 10 64bit)</li> <li>• 128GB SSD</li> <li>• 240GB SSD</li> </ul>
<b>Serial Port</b>	(1) RJ45 Serial
<b>USB Ports</b>	<ul style="list-style-type: none"> <li>• (1) USB Type C</li> <li>• (2) USB Type A</li> </ul>
<b>Ethernet</b>	10/100/1000 Ethernet Cable
<b>Cash Drawer Port</b>	12 V or 24 V Dual Cash Drawer Support <b>Note:</b> A Y Cable is required when connecting to any 12 V cash drawer or to dual cash drawers.
<b>Secure Chip Reader</b>	Sim card reader
<b>Options</b>	<ul style="list-style-type: none"> <li>• MSR</li> <li>• 2D Scanner (front-mount or rear-mount)</li> <li>• WiFi (802.11 a/b/g/n/ac)</li> <li>• Biometrics</li> <li>• MSR + Biometrics</li> <li>• 2-in-1 Sign-In</li> </ul>
<b>Customer Display</b>	<ul style="list-style-type: none"> <li>• 7" Customer Display</li> <li>• 2x20 Display, Integrated, External RJ45 Cable</li> <li>• Double Byte Display, Integrated, External Cable</li> </ul>

Feature	Description
<b>Expansion Option</b>	Optional I/O Expansion Box OR Integrated I/O Expansion with the following ports: <ul style="list-style-type: none"><li>• (1) 24V PUSB</li><li>• (2) 12V PUSB</li><li>• (1) RJ45</li><li>• Power In</li></ul>
<b>Stand Options</b>	<ul style="list-style-type: none"><li>• 7746 Stand</li><li>• 7746 Stand with Battery</li></ul>
<b>Power Supply</b>	12VDC, 40W, DOE VI, Barrel Connector
<b>Power Cords</b>	<ul style="list-style-type: none"><li>• USA Power Cord</li><li>• EU Power Cord</li><li>• UK Power Cord</li><li>• Australia Power Cord</li><li>• China Power Cord</li><li>• India Power Cord</li><li>• Swiss Power Cord</li></ul>

## Mounting Configurations

### With 7746 Stand



7746-F170 – 7746 Stand  
7746-F171 – 7746 Stand, Orderman Logo

CCP-73917

### With 7746 Stand with Battery



7746-F172 – 7746 Stand with Battery  
7746-F173 – 7746 Stand with Battery, Orderman Logo

CCP-73918

### With XL7 Customer Display



7746-F452 – XL7 7" PCAP Touch Display, Integrated  
7746-F455 – XL7 7" Non-Touch Display, Integrated

CCP-73919

### With 2x20 Customer Display



7746-F456 – 2x20 Display, Integrated, External RJ45 Cable  
7746-F457 – Double Byte Display, Integrated, External RJ45 Cable

CCP-75948

## I/O Expansion

The NCR PX10/PX15 POS (7746) offers an optional I/O Expansion for added connectivity. When using the I/O Expansion option, a 150 watt power supply is required. The I/O Expansion provides direct power to the PX10/PX15 terminal.

There are two I/O Expansion options:

- [I/O Expansion Box \(7746-F122\)](#) below
- [I/O Expansion Integrated Stand \(7746-F123\)](#) on the facing page

### I/O Expansion Box (7746-F122)

The I/O Expansion is external to the terminal and can be placed under the counter for a clean countertop.

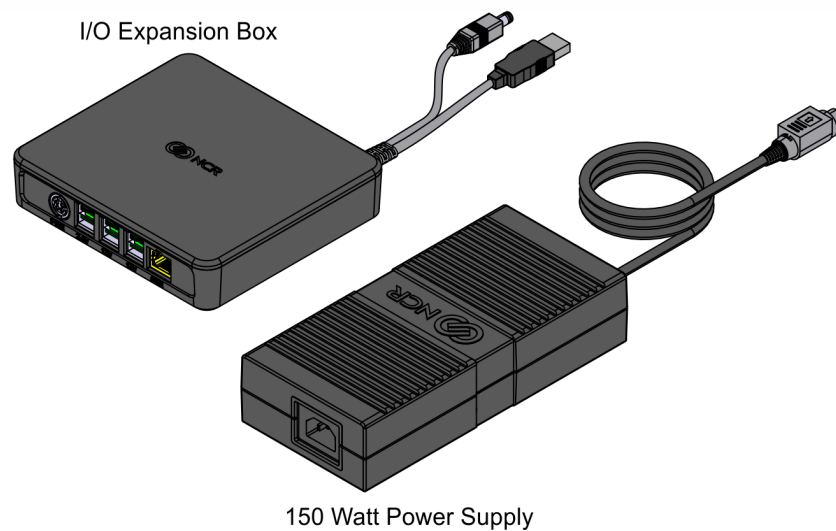

CCP-73978

### Connectors

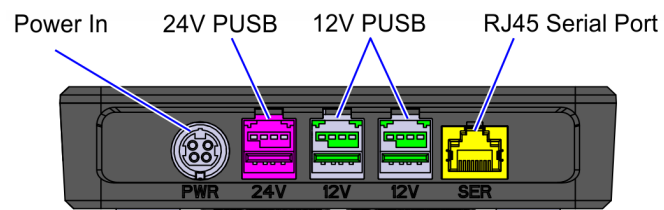

CCP-73979

## I/O Expansion Integrated Stand (7746-F123)

The NCR PX10/PX15 POS (7746) Terminal can be secured on top of the Integrated I/O Base for an integrated countertop option.

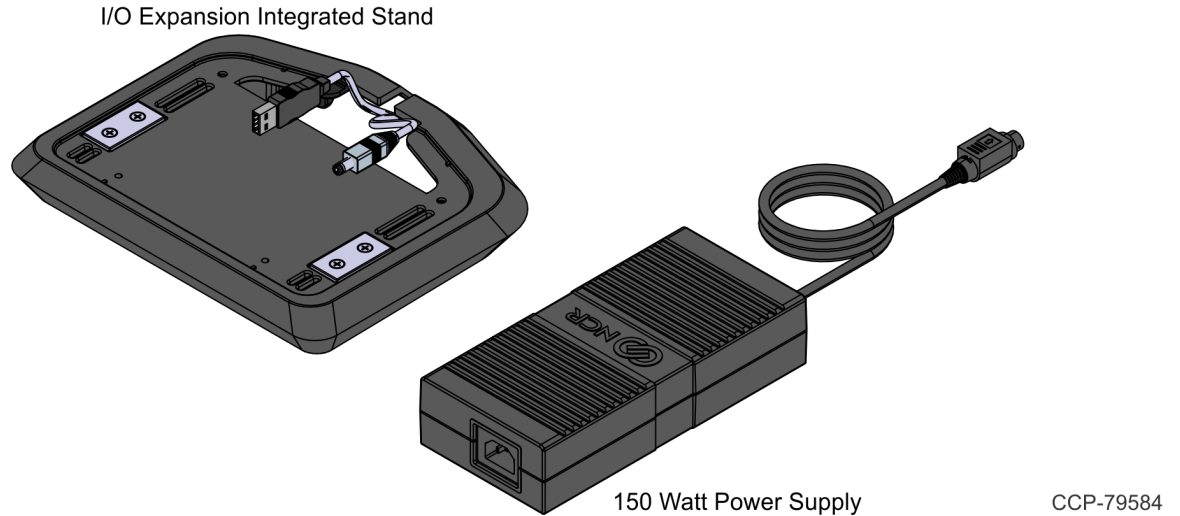

### Connectors

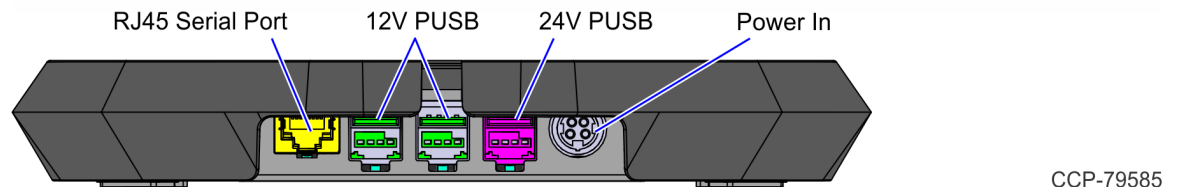

## Scanner

### Programming the Scanner

To program the scanner to work on a Retail or Hospitality (Aloha) POS, refer to the following sections in the Imager Setup Sheets document (BCC5-0000-5470):

<https://onlinehelp.ncrvoyix.com/Retail/Scanners/ImagerSetup/HTML/FrontMatter-HTML/Home.htm>

- **Retail**
  - Honeywell N3680 Retail Quick Imager Setup
- **Hospitality (Aloha)**
  - Honeywell N3680 Aloha Programming Sheet



# Specifications

Feature	Specification
<b>CPU</b>	Intel® Dual-core N3350 processor (up to 2.4Ghz)
<b>Volatile Memory</b>	4GB or 8GB LPDDR4
<b>Networking</b>	Auto-selecting 10/100/1000 Base-T Ethernet using TCP/IP
<b>Primary Display</b>	<ul style="list-style-type: none"> <li>• 10.1" Display               <ul style="list-style-type: none"> <li>• 10.1" color TFT</li> <li>• 1920x1200 Full HD resolution</li> <li>• 8-bit color</li> <li>• 340 nit</li> <li>• 30K hours</li> </ul> </li> <li>• 15.6" Display               <ul style="list-style-type: none"> <li>• 15.6" color TFT/LCD</li> <li>• 1920x1080 Full HD resolution</li> <li>• 8-bit color</li> <li>• 300 nit</li> <li>• 30K hours</li> </ul> </li> </ul>
<b>Touch Screen</b>	Projected Capacitive
<b>Storage</b>	32GB, 64GB, 128GB, or 240GB SSD options (higher capacity may available upon request)
<b>Enclosure</b>	<ul style="list-style-type: none"> <li>• PC/ABS blend flame retardant resin</li> <li>• High conductivity ADC1 cast aluminum</li> </ul>
<b>Dimensions (L x W x H) (Countertop envelope through tilt angle)</b>	Max countertop envelope/footprint with display facing up: <ul style="list-style-type: none"> <li>• 10.1" Display               <ul style="list-style-type: none"> <li><b>Without MSR/Sidecar</b> 265 mm x 160 mm x 247 mm (10.4 in. x 6.3 in. x 9.7 in.)</li> <li><b>With MSR/Sidecar</b> 272 mm x 160 mm x 247 mm (10.7 in. x 6.3 in. x 9.7 in.)</li> </ul> </li> <li>• 15.6" Display               <ul style="list-style-type: none"> <li><b>Without MSR/Sidecar</b> 379 mm x 160 mm x 275 mm (14.9 in. x 6.3 in. x 10.8 in.)</li> <li><b>With MSR/Sidecar</b> 386 mm x 160 mm x 275 mm (15.2 in. x 6.3 in. x 10.8 in.)</li> </ul> </li> </ul>
<b>Base Dimension (L x W)</b>	160 mm x 189 mm (6.3 in. x 7.4 in.)

Feature	Specification
<b>Tilt Angle</b>	20° to 75° from vertical, as measured tilting down from vertical top
<b>Terminal Weight</b>	<ul style="list-style-type: none"> <li>• 1.8 kg (3.9 lbs) for 10.1" version with MSR.</li> <li>• 2.4 kg (5.4 lbs) for 15.6" version with Biometrics.</li> </ul> Varies by configuration. See Site Preparation Guide for details.
<b>Operating Temperature</b>	0°C to 40°C (32°F to 104°F)
<b>Storage Temperature</b>	-20°C to 60°C (-4°F to 140°F) Must be in original pack material in humidity and temperature controlled environment.
<b>Humidity</b>	10% to 90%, non-condensing
<b>Environmental Compliance</b>	RoHS, WEEE
<b>EMI Certifications</b>	FCC Class A, CE, C-Tick
<b>Safety Certifications</b>	TUV, CB Scheme

# Operator Controls

The NCR PX10/PX15 POS (7746) has the following operator control buttons:

- [Power Button](#) below
- [Recovery Tool Button](#) on the facing page

## Power Button

The Power Button is located on the Front Base. This switch is a momentary contact, push-on-push-off switch.



Power Button with LED

CCP-73920

## Recovery Tool Button

The Recovery Tool Button is for the OS Recovery Tool option. The recessed blue button is located on the bottom of the unit and can be accessed with a pen, stylus, or similar pointed object. The button is a momentary contact, push-on-push-off switch.

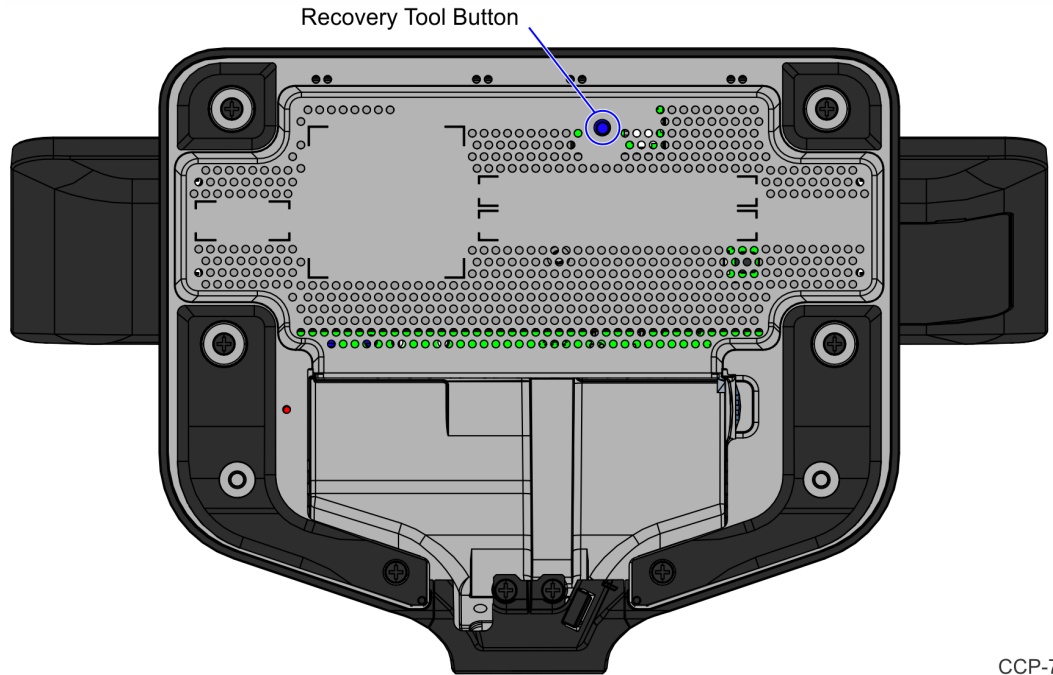

## Label Locations

The serial number and model number are included on the Certification Label located on the bottom of the terminal. A Microsoft Certificate of Authenticity (COA) label is included if the terminal is ordered and shipped with a pre-installed Microsoft operating system.

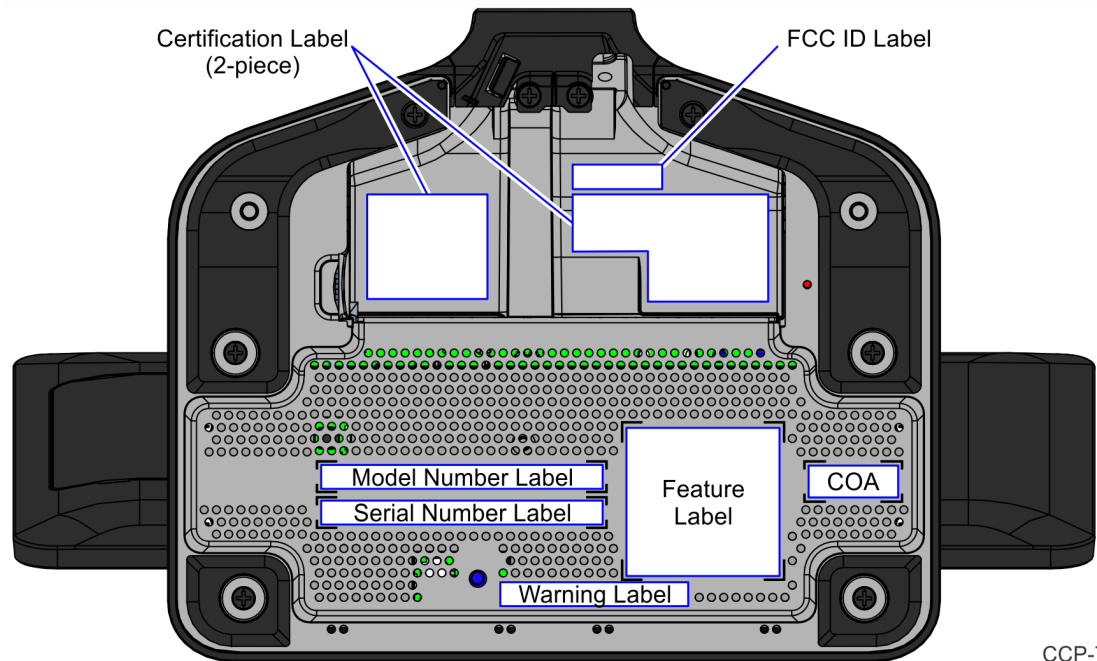

CCP-73928

---

## Chapter 2: **Hardware Installation**

---

This section explains how to perform an out-of-box installation of the NCR PX10/PX15 POS (7746) hardware and its respective peripheral devices.

### Installation Restrictions

Before installing the NCR PX10/PX15 POS (7746), read and follow the guidelines in the *NCR PX10/PX15 POS (7746) Site Preparation Guide* (BCC-0000-5288) and the *NCR Workstation and Peripheral AC Wiring Guide* (BST0-2115-53).

- Install the NCR PX10/PX15 POS (7746) near an electrical outlet that is easily accessible. Use the power cord as a power disconnect device.
- Do not permit any object to rest on the power cord. Do not locate the NCR PX10/PX15 POS (7746) where the power cord can be walked on.



**Caution:** Use a grounding strap or touch a grounded metal object to discharge any static electricity from your body before servicing the NCR PX10/PX15 POS (7746) terminal.

# Installation Notes

## Cable Restraint

The NCR PX10/PX15 POS (7746) includes cable management features to prevent accidental disconnects and tampering. Some connectors include locking mechanisms and cables that can be routed through the slot in the base.

## Footprint

An area of no less than 45 square inches is necessary to properly install a PX10 unit with MSR. This will accommodate the unit as well as its associated mounting hardware. For terminals with customer display, refer to the *NCR PX10/PX15 POS (7746) Site Preparation Guide* (BCC5-0000-5288) for specific dimensions.

## Power

The NCR PX10/PX15 POS (7746) includes a 12V power supply as standard. With the powered USB 24V option, a 24V external power brick is used. The source power of the PX10/PX15 is drawn from a regular AC wall outlet. The electronics are “universal” – that is, they will function when connected to standard wall outlets in most countries around the world. For use in locales other than North America, special wall outlet adapters or cables will be required. For international configurations, the country-specific power cord is ordered separately.

## Moisture

The terminal should not be installed in areas where it might be exposed to direct water spray. PX10/PX15 units are not meant for outdoor installation.

## Magnetic Stripe Reader (MSR) Cleaning



**Caution:** Prior to cleaning, please ensure that the terminal is not connected to a power supply and not powered on.

Periodically, the MSR may need to be cleaned depending on usage. Pre-saturated MSR cleaning cards can be ordered from NCR (50/box) using part number 1666-K024. Otherwise, wrap a card with a saturated paper towel of glass cleaner and swipe gently to clean the reader head.

Do not use chlorine-based cleaners, such as Clorox bleach, non-chlorine bleach, or chlorine-based bathroom or mildew cleaners. Also, do not use solvents such as acetone, MEK, TCE, paint thinner, or turpentine.

## Hardware Platform Drivers

The NCR PX10/PX15 POS (7746) uses the new NCR GEN3 drivers set. GEN3 drivers are available on:

[https://www5.ncr.com/support/support\\_drivers\\_patches\\_radiant.asp?Class=Hospitality/display](https://www5.ncr.com/support/support_drivers_patches_radiant.asp?Class=Hospitality/display)



## Ergonomic Workplace

The NCR PX10/PX15 POS (7746) has a high-brightness LCD with an anti-glare screen. For best results, please observe the following when considering the terminal workplace:

- Avoid direct-glaring and reflective-glaring light. Locate the terminal in a controlled luminance surrounding. When installed next to windows position the terminal so it does not reflect the outside light.
- If possible, avoid reflective glaring caused by electric light sources.
- Position the terminal for ideal viewing angles.

# Installing the Terminal

The NCR PX10/PX15 POS (7746) comes fully assembled and ready to use. All that is required is to connect the LAN cable and peripheral device cables to the I/O Panel.

For more information about the default Terminal I/O for the NCR PX10/PX15 POS (7746), refer to [Terminal I/O](#) on page 22.

## Connecting AC Power

1. Connect the Power Supply cable to the Power Input Port on the terminal.

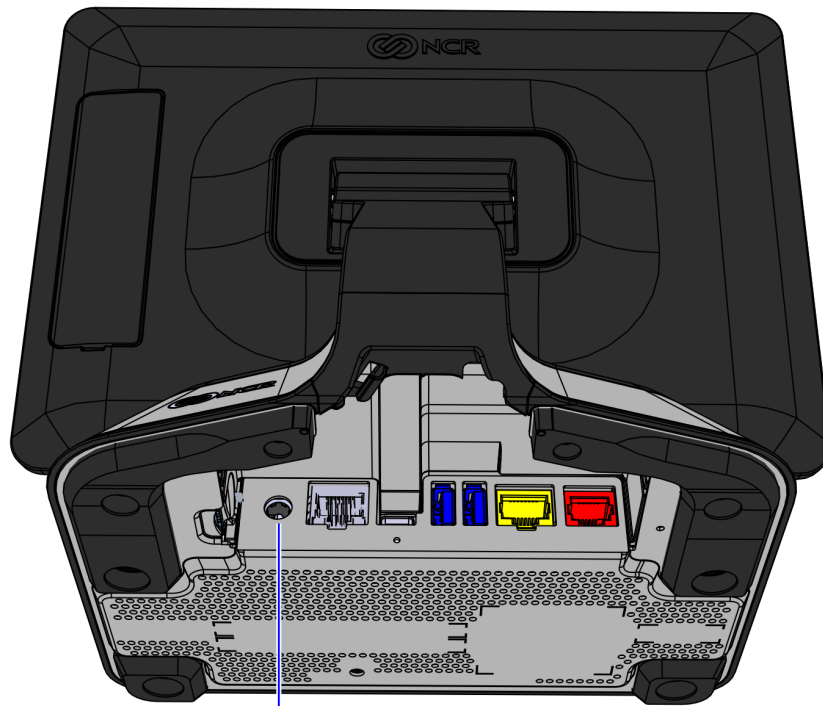

Power Input Port

CCP-73931

2. Connect the AC Power Cord to the Power Supply and to an AC outlet.

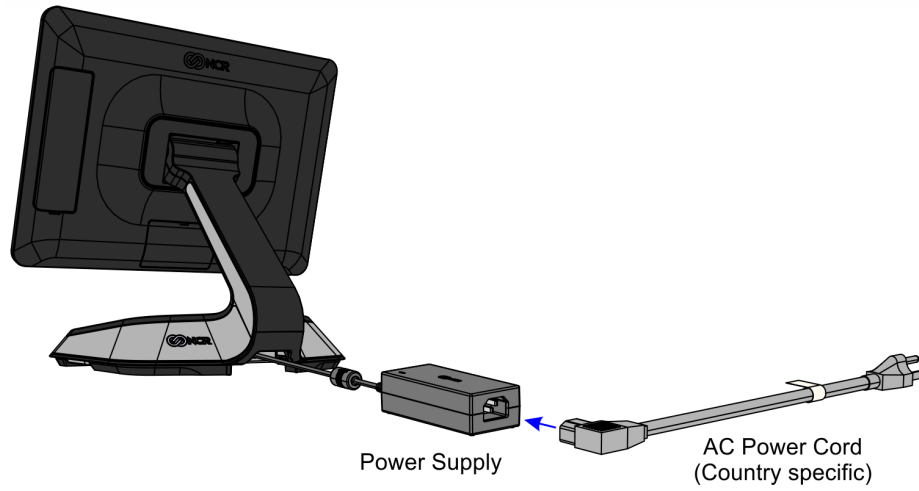

## Connecting to a Network

Most business configurations require the PX10/PX15 system to connect to a network. Connecting to a network enables communicating with other systems and devices also on the network. Depending on business configurations, connecting to a network may allow connection to the Internet.

To connect the PX10/PX15 terminal to a network, plug the 10/100/1000 Ethernet cable into the port labeled LAN on the bottom panel. The other end of the 10/100/1000 Ethernet cable should be connected into the network hub.



**Note:** Consult with your business Information Technology (IT) representative to determine the available connection, and to locate the network hub.

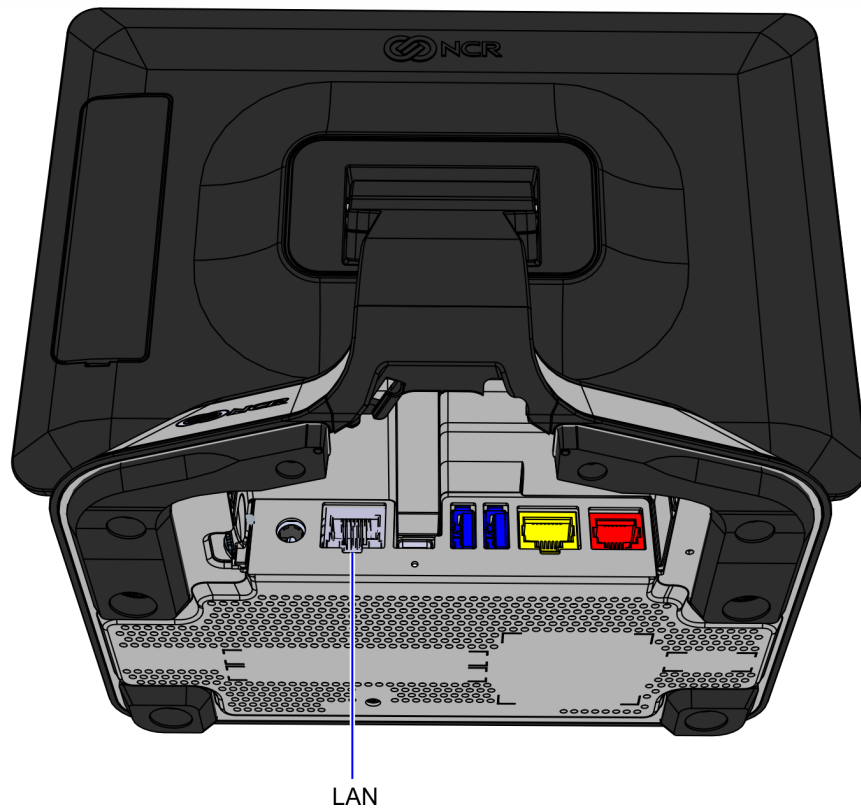

## Starting Up the Terminal

To run the operating system and to access software and data, start up the PX10/PX15 platform. To start up the PX10/PX15, complete the following procedure:

1. Plug the power cord into an electrical outlet.
2. Press the Power Button on the Front Base of the terminal. The unit can later be configured by software to power on without pressing the switch.



Power Button with LED

CCP-73920

The system installs the system devices, configures system settings, and then reboots to continue setup. Complete the System Setup. This varies from OS to OS, but the following initial setup procedures are typical:

- Starting Windows
- Preparing the computer for the first time
- Checking video performance

3. Accept the **License Terms Agreement**.



**Note:** Depending on the installed operating system and the selected settings, the amount of time it takes to boot up may vary.

# Installing the Cash Drawer

The Cash Drawer can be connected to the PX10/PX15 terminal or to the transaction printer.

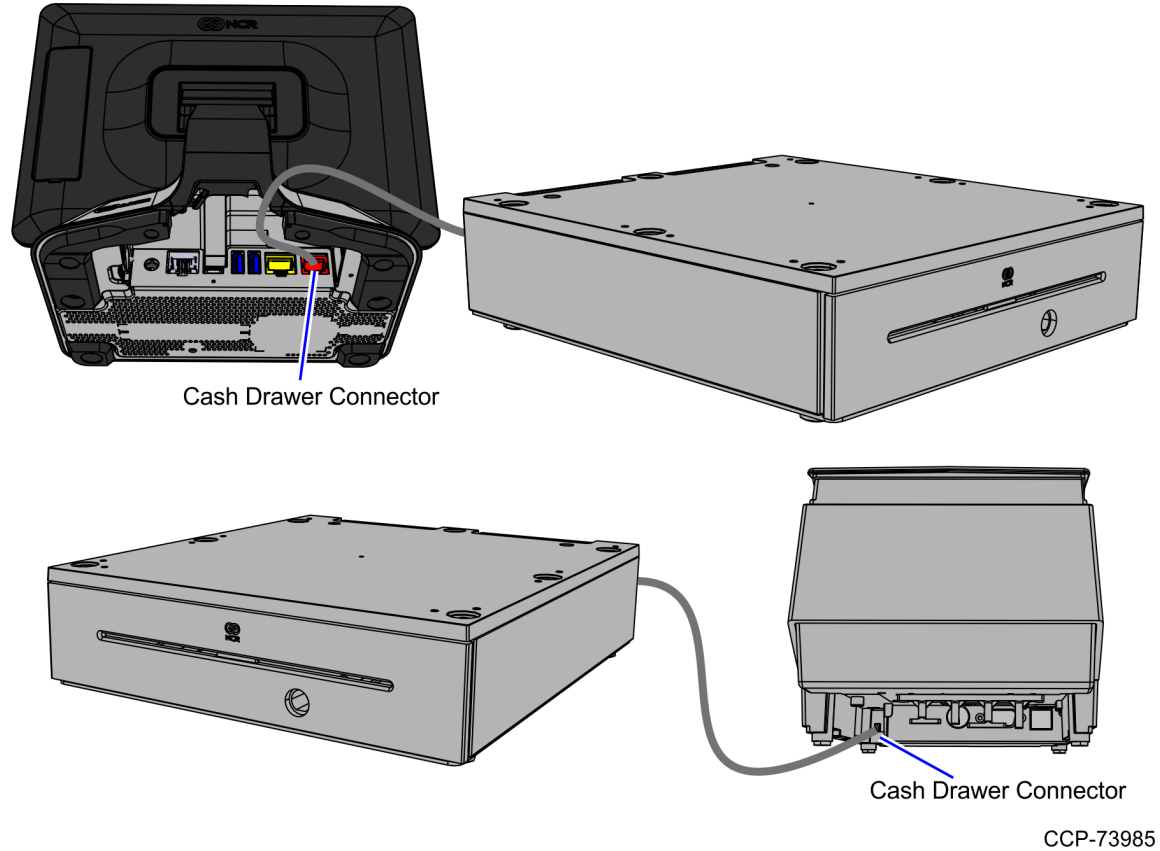

## Second Cash Drawer Cable Connection

The terminal supports a two-drawer configuration with a Dual Cash Drawer Cable. Connect this cable to the terminal or transaction printer cash drawer connector.

There are two versions of the Dual Cash Drawer Cable:

- 1432-C516-0009 (24V) — for dual 24V cash drawers
- 1432-C517-0009 (12V) — for single or dual 12V legacy cash drawers



**Caution:** The two cables look very similar. Make sure you use the correct one. Connecting the wrong cable can cause system damage.

# Terminal I/O

The following is the default Terminal I/O for the NCR PX10/PX15 POS (7746).

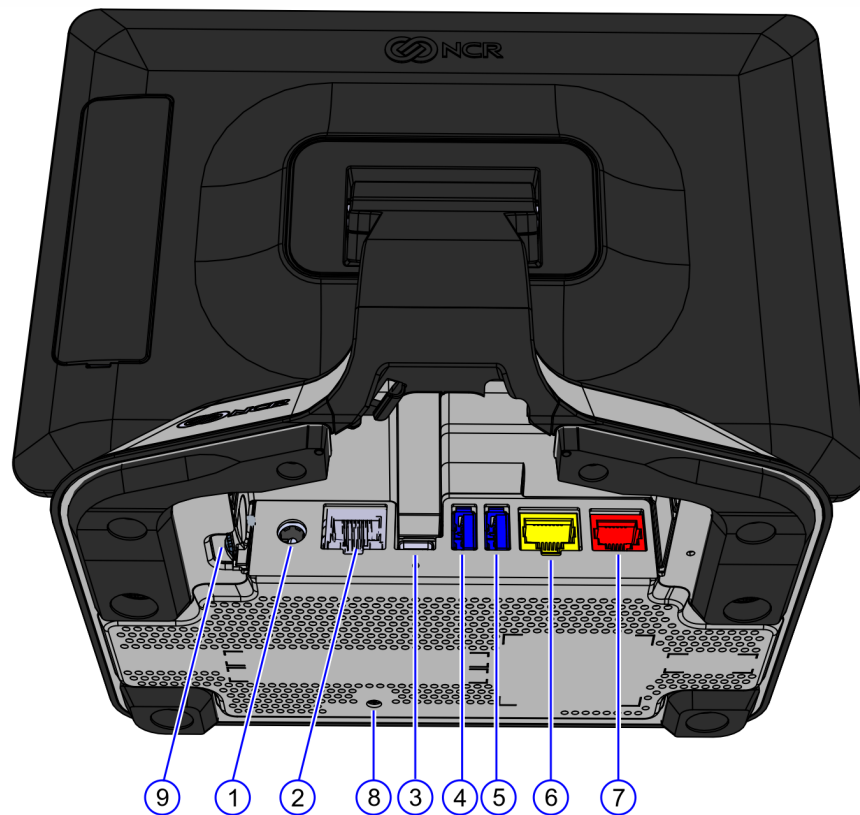

CCP-73927

Callout	I/O Name
1	Power Input Port
2	LAN
3	USB type C
4	USB 3.0
5	USB 3.0
6	RJ45 serial port
7	RJ12 Cash Drawer (24V)
8	Recovery Tool button
9	SIM Card Reader (Smart Card Reader)

## Power In

The 7746 Motherboard receives +12V  $\pm$ 10% input power from the power brick via DC-in barrel jack on the rear I/O.

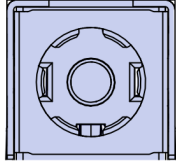

CCP-73980

Pin	Signal Name
Center Pin	+12V_IN
Outer Pin	GND

## LAN

The 7746 Motherboard provides 10/100/1000 Base T Ethernet support using Realtek RTL8111F controller. The connector features an integrated magnetic module and two LEDs. The LEDs provide speed, link and activity status.

### LAN Cable

Product ID	Description
7746-F110	10/100/1000 Ethernet cable

### 10/100/1000 Ethernet Cable (7746-F110)

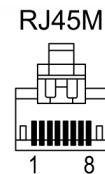
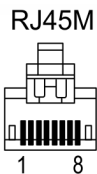

CCP-73991

RJ45M Pin	Signal Name	RJ45M Pin
1	24AWG (Twisted Pair 1)	1
2	24AWG (Twisted Pair 1)	2
3	24AWG (Twisted Pair 2)	3
4	24AWG (Twisted Pair 2)	4
5	24AWG (Twisted Pair 3)	5



---

RJ45M Pin	Signal Name	RJ45M Pin
6	24AWG (Twisted Pair 3)	6
7	24AWG (Twisted Pair 4)	7
8	24AWG (Twisted Pair 4)	8

## USB Type C Port

The 7746 Motherboard provides a standard male USB-C connector. The USB-C port provides connection for the following:

- Display Port video
- USB3.0 data link
- Up to 3A/5V power
- 3A/12V power (NCR peripherals only)

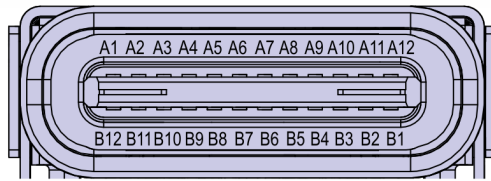

CCP-73981

Pin	Signal Name	Pin	Signal Name
A1	GND	B12	GND
A2	SSTXp1	B11	SSRXp1
A3	SSTXn1	B10	SSRXn1
A4	V <sub>BUS</sub>	B9	V <sub>BUS</sub>
A5	CC1	B8	SBU2
A6	Dp1	B7	Dn2
A7	Dn1	B6	Dp2
A8	SBU1	B5	CC2
A9	V <sub>BUS</sub>	B4	V <sub>BUS</sub>
A10	SSRXn2	B3	SSTXn2
A11	SSRXp2	B2	SSTXp2
A12	GND	B1	GND

## USB 3.0 Ports

The 7746 Motherboard provides two standard USB 3.0 ports. Each USB 3.0 port is capable of supplying +5V at 0.9A max. The color of the connectors is blue.

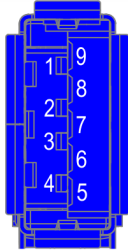

CCP-73982

Pin	Signal Name
1	V <sub>BUS</sub>
2	D-
3	D+
4	GND
5	Rx-
6	Rx+
7	GND
8	Tx-
9	Tx+

## RJ45 Serial Port

The RJ45 port is an unshielded 8-pin “tab down” RJ45 connector. The color of the connector is yellow.

Current limiting power switches provide 12V on the RTS pin with a limit current of 0.5A, and 5V on the DTR pin with a limit current of 1A.

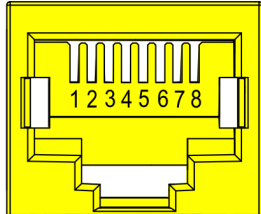

CCP-73983

Pin	Signal Name
1	DSR
2	DCD
3	DTR/5V
4	GND
5	RX
6	TX
7	CTS
8	RTS/12V

### RJ45 Adapter Cables

If a peripheral device requires a different connector to connect to the PX10/PX15 terminal RJ45 serial port, order the following adapter kits:

Product ID	Description
1639-K332	RJ45M to DB25M adapter cable, 1.85m (72.8 in.)
1639-K333	RJ45M to DB9M adapter cable, 1.85m (72.8 in.)
1639-K435	RJ45M to HSR RJ12 serial converter dongle, 0.46m (18.0 in.)
1639-K436	RJ45M to RJ45F remote serial printer converter dongle, 0.46m (18.0 in.)
1639-K438	RJ45M to DB9F printer cable, 1.85m (72.8 in.)

### RJ45M to DB25M Adapter Cable (1639-K332)

RJ45M

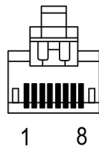

DB25M

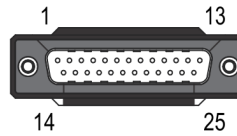

CCP-73994

RJ45M Pin	Signal Name	DB25M Pin
1	DSR	20
2	DCD	8
3	DTR	6
4	GND	7
5	RXD	2
6	TXD	3
7	CTS	4
8	RTS/12V	5

### RJ45M to DB9M Adapter Cable (1639-K333)

RJ45M

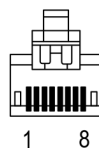

DB9M

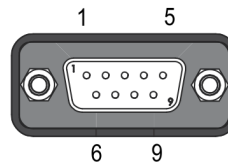

CCP-73995

RJ45M Pin	Signal Name	DB9M Pin
2	DCD	1
5	RXD	2
6	TXD	3
3	DTR	4
4	GND	5
1	DSR	6
8	RTS	7

RJ45M Pin	Signal Name	DB9M Pin
7	CTS	8
NC	RI	9

**RJ45M to HSR RJ12 Serial Converter Dongle (1639-K435)**

RJ45M

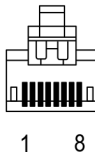

RJ12

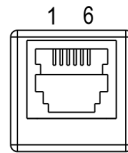

CCP-73996

RJ45M Pin	Signal Name	RJ12 Pin
8	RTS	1
2	N/C	2
6	TX	3
5	RX	4
4	GND	5
7	CTS	6
3	N/C	—
1	N/C	—

**RJ45M to RJ45F Remote Serial Printer Converter Dongle (1639-K436)**

RJ45M

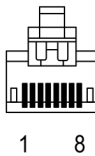

RJ45F

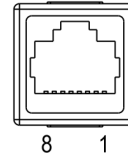

CCP-73997

RJ45M Pin	Signal Name	RJ45F Pin
8	N/C	—
2	N/C	—
6	TX	3
5	RX	2

RJ45M Pin	Signal Name	RJ45F Pin
4	GND	5
7	CTS	8
3	N/C	—
1	N/C	—

### **RJ45M to DB9F Printer Cable (1639-K438)**

RJ45M

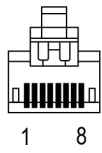

DB9F

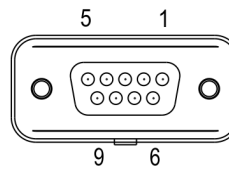

CCP-73998

RJ45M Pin	Signal Name	DB9F Pin	Signal Name
2	DCD	1	DCD
6	TX	2	RX
5	RX	3	TX
1	DSR	4	DTR
3	DTR	5	DSR
4	GND	6	GND
7	CTS	7	RTS
8	RTS	8	CTS
NC		9	RI
	GND	SHELL	GND

## RJ12 Cash Drawer Port

A single 6-position RJ12 connector is used supporting dual +12V or +24V cash drawer. The color of the connector is red.

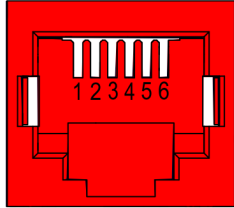

CCP-73984

Pin	Signal Name
1	Logic GND
2	Solenoid A
3	Drawer A/B Open/Close Status
4	+24V
5	Solenoid B
6	Power GND

### Cash Drawer Cables

The terminal supports a 2-drawer configuration with a Dual Cash Drawer Cable. Connect this cable to the terminal or transaction printer cash drawer connector.



**Note:** When connecting a single 12V legacy cash drawer, the 1432–C517–0009 cable is required to be used.

Product ID	Description	Configuration Notes
1432-C516-0009 (24V)	24V cash drawer cable splitter	Required when connecting dual 24V cash drawers
1432-C517-0009 (12V)	12V cash drawer cable splitter	Required when connecting single or dual 12V legacy cash drawer(s)



### 24V Cash Drawer Cable Splitter (1432-C516-0009)

RJ12 (Front View)

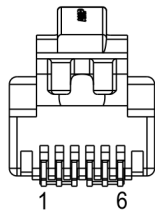

Dual Cash Drawer (Top View)

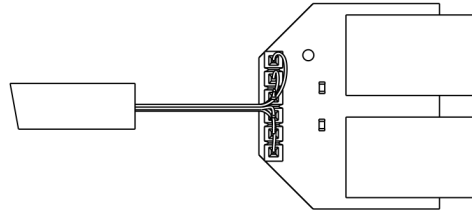

CCP-73992

RJ12 Pin	Color	Signal Name	Dual Cash Drawer
1	Blue	Frame GND	1
2	Yellow	Kick-out Signal	2
3	Green	Open/Close Status	3
4	Red	+24V	4
5	Black	Kick-out Signal 2	5
6	White	Signal GND	6

### 12V Cash Drawer Cable Splitter (1432-C517-0009)

RJ12 (Front View)

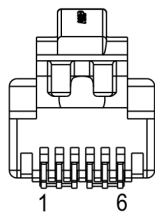

Dual Cash Drawer (Top View)

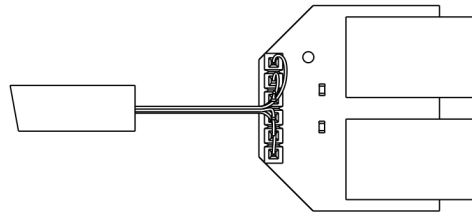

CCP-73992

RJ12 Pin	Color	Signal Name	Dual Cash Drawer
1	Blue	N/C	1
2	Yellow	CD Kick-out Signal A	2
3	Green	CD Open Con	3
4	Red	N/C	4
5	Black	CD Kick-out Signal B	5
6	White	Signal GND	6

## SIM Card Reader

The 7746 Motherboard provides one smart card reader for full size SIM using Microchip SEC1110 Smart Card Bridge to USB. The Smart Card Bridge to USB is connected to the one of the downstream port of the USB 2.0 Hub 4-Port internally. SIM slot is located at the bottom side of the unit with a label and insert arrow "SIM".



---

# Chapter 3: **Disk Image Backup and Recovery Tool**

---

## Introduction

This section discusses procedures on how to backup or recover the POS image. The terminal has a recovery tool that performs a complete backup of the whole HDD/SSD. This includes the operating system, all files, data and the database itself if it is installed on the HDD/SSD, making an exact duplicate of everything contained on the terminal.

The *Recovery Tool* uses the Windows Image (.WIM) file format to store the OS image. This is a file-based format for use with the ImageX and DISM tools that Microsoft created for use with Windows Vista and later OS versions. The format can also be used to capture and restore XP-based OS images. More information on the ImageX tool and .WIM format can be found at:

[http://technet.microsoft.com/en-us/library/cc722145\(WS.10\).aspx](http://technet.microsoft.com/en-us/library/cc722145(WS.10).aspx)

The *Recovery Tool* is designed to create a complete backup of, or restore, a previously saved image to the terminal.

The Recovery Tool offers the following functions and features:

- Multi-language support for the following languages: EN; DE; FR; IT; ES.
- Check and Repair Disk
- Backup the System
- Restore the System to a previous state
- Password Protection
- Network support

You can save and restore your backup from different locations:

- Network
- USB Drive
- Hard Drive/Solid State Device (if present on the terminal)

# Running the Recovery Tool

## Starting the Recovery Tool

The Recovery Tool Button is located on the bottom of the terminal.

1. Begin with terminal OFF.
2. Using a pen, stylus, or similar object, press and hold the recessed **Recovery Tool Button**. While holding the **Recovery Tool Button**, momentarily press the **Power Button**.
3. Continue holding the **Recovery Tool Button** for 5 to 6 seconds.

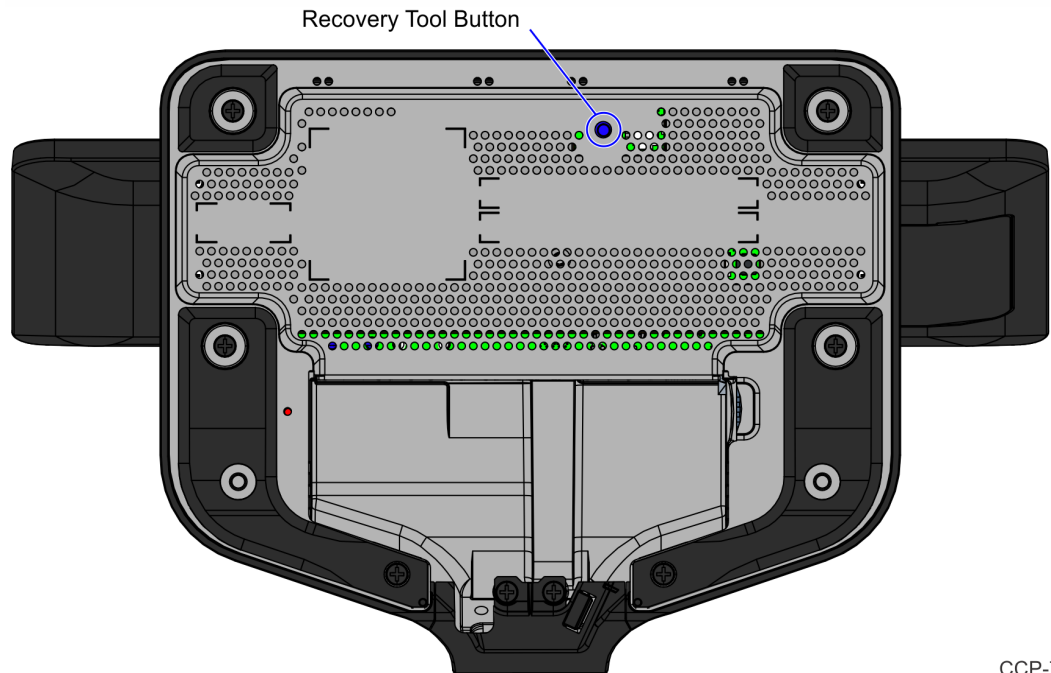

## Main Screen

When the terminal boots the *Main Screen* is displayed.

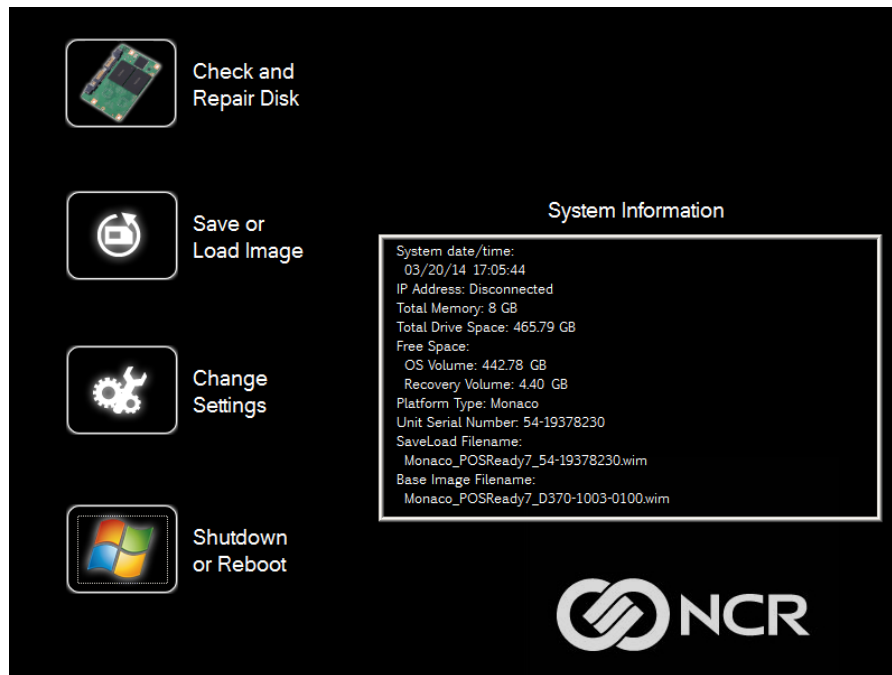

### Check and Repair Disk

This button runs *Checkdisk*, which checks the consistency of the HDD/SSD and the Windows file system. Failures can occur in the Windows file system and prevent Windows from starting. *Checkdisk* analyzes the failures and fixes them in most cases. This function runs in a Windows Command Box.

### Save or Load Image

This button opens the *Backup and Recovery* screen.

### Change Settings

This button opens a dialog screen to let you set/change the password and to configure the network settings.

### Shutdown or Reboot

This button opens the screen to properly *Shutdown* and *Reboot* the POS.

### System Information

This is where useful information of the POS is displayed, such as Serial Number and Image Names.

## Save or Load Image

This function is used to either *Save* or *Load* an image from a device.

1. On the *Main Screen*, select **Save or Load Image**.

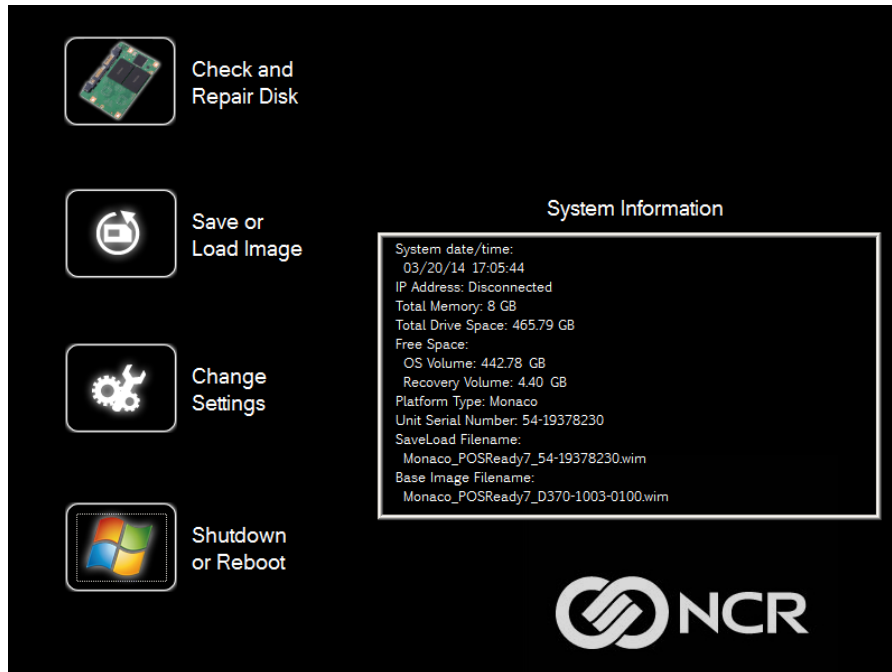

2. Enter the **Password**. The factory default password is **Recovery1234**.

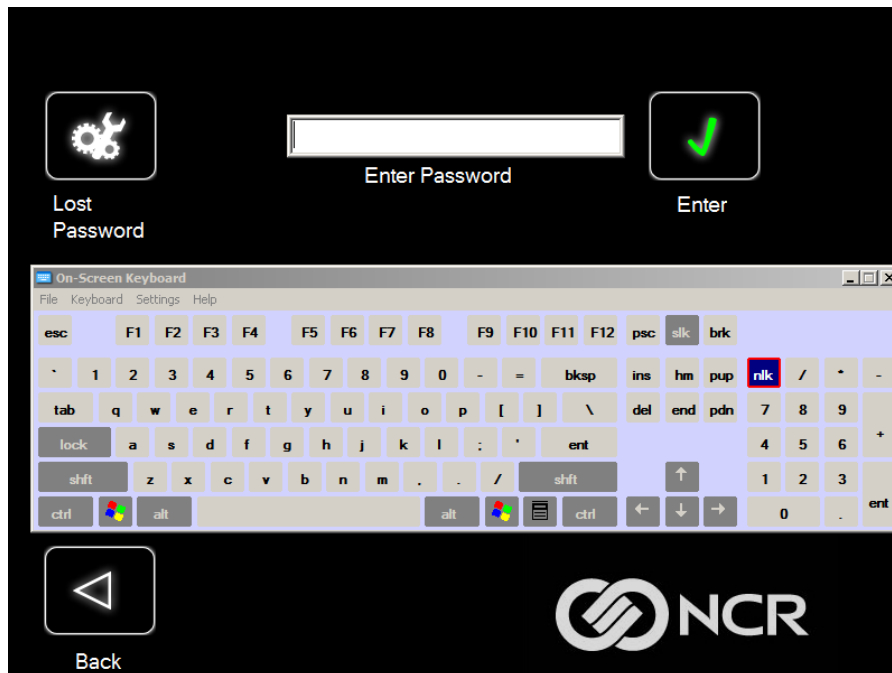

## Saving an Image

The *Select Image Location* screen displays a terminal with three sets of *In/Out* arrow buttons, indicating the direction of data flow when selected. Arrows pointing away from the terminal are used to *Save* images to a device. Arrows pointing towards the terminal are used to *Load* an image.

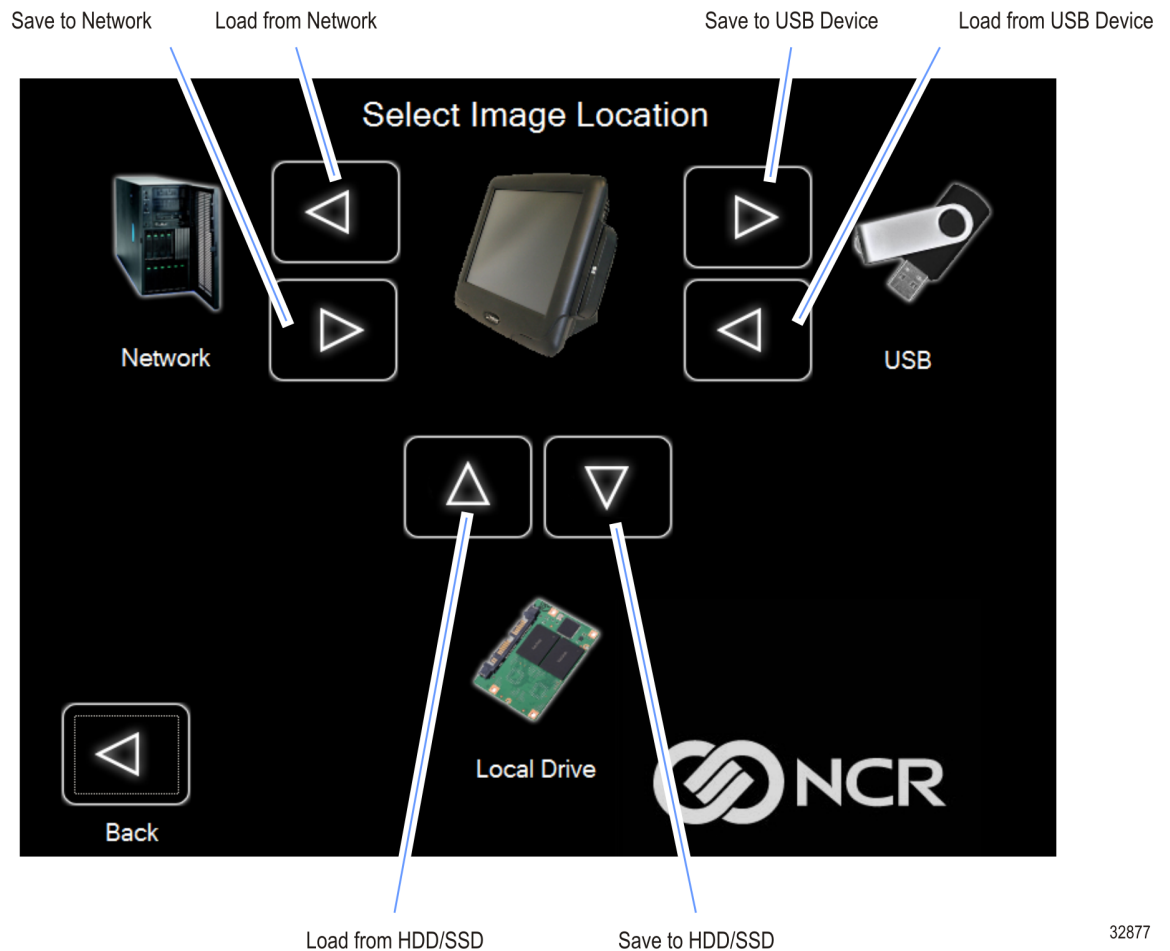

32877

### **Recovery Partition Size**

The size of the Recovery Partition is limited to 8GB on the local drive. The USB and network options can be used to store / backup larger images. The total size is comprised of the base factory image + the user and site backups and the roughly 300MB of space used by WinPE and apps. USB/Network backups are limited only by the hardware that they are being stored to.

After the factory image is copied into the Recovery Partition, there are approximately 3GBs remaining in the 8GB partition. Any data stored as an incremental backup to this location is compressed. A typical, large POS software installation will not outpace the constraints of the local storage.



Backups to separate *slots* in the Recovery Tool only increase the total storage required by the amount of data *added* to the image. When the contents of the OS partition become too large to store in the 8GB local Recovery Partition, then one of the alternate storage methods available (USB or network) should be used to store backups.

### Output Options

There are three output options.

- Hard Disk Drive/Solid State Device
- USB Device
- Network



**Note:** Windows 7 images require a minimum of 4GB available on the Network, Local Drive, or USB drive. "POSReady 7" requires a minimum of 2GB. Make sure there is enough space is available on the storage media. Image sizes vary depending on applications and database sizes.

1. Select the arrow that points to the desired output.

**Example:** Select the **USB Save Button**.



2. Select the **USB Button**.

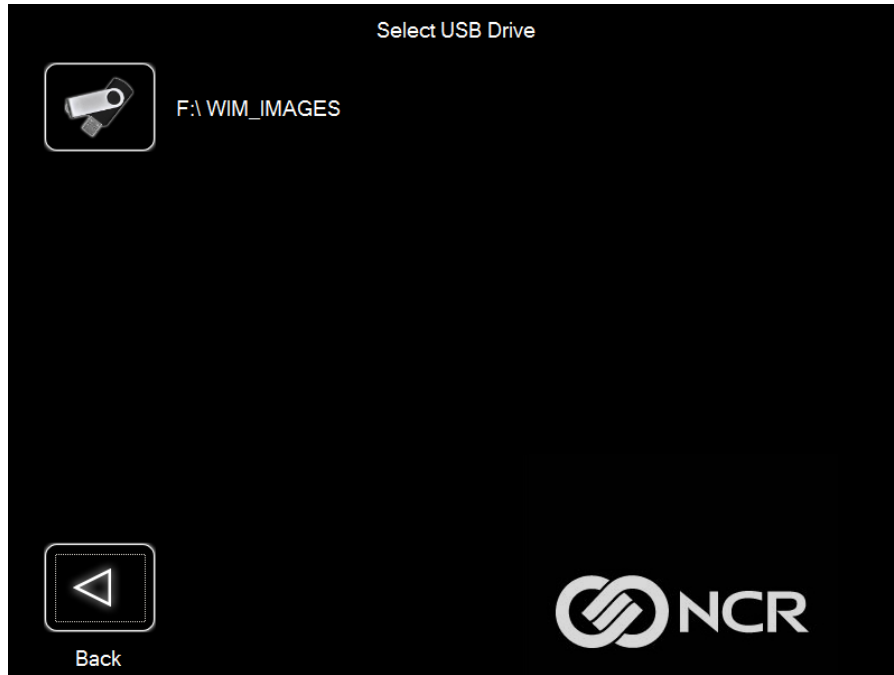

If this is the first backup performed on this POS, the image is automatically saved as a *Site* backup.



If a backup already exists, you have the choice of performing either a *Site* or *User* backup.

- **Site Image** - Use this option immediately after all application components have been loaded and set up for initial operation or for base image updates.
- **User Image** - Use this option for routine day-to-day or periodical backups.



**Note:** *Site* and *User* backups are separate independent backups.



The image information is updated with the new image date.

## Loading An Image



**Caution:** Do NOT remove power during an Image Load. Complete the Operating System setup and then shut down Windows properly. Removing power prematurely will corrupt the image and display various messages like "Windows failed to load" or "missing or corrupt registry". If this happens you can do an Image load of the Factory image with the Recovery Tool.

1. Select the arrow that points from the desired load device to the terminal.

**Example:** Select the **USB Load Button**.

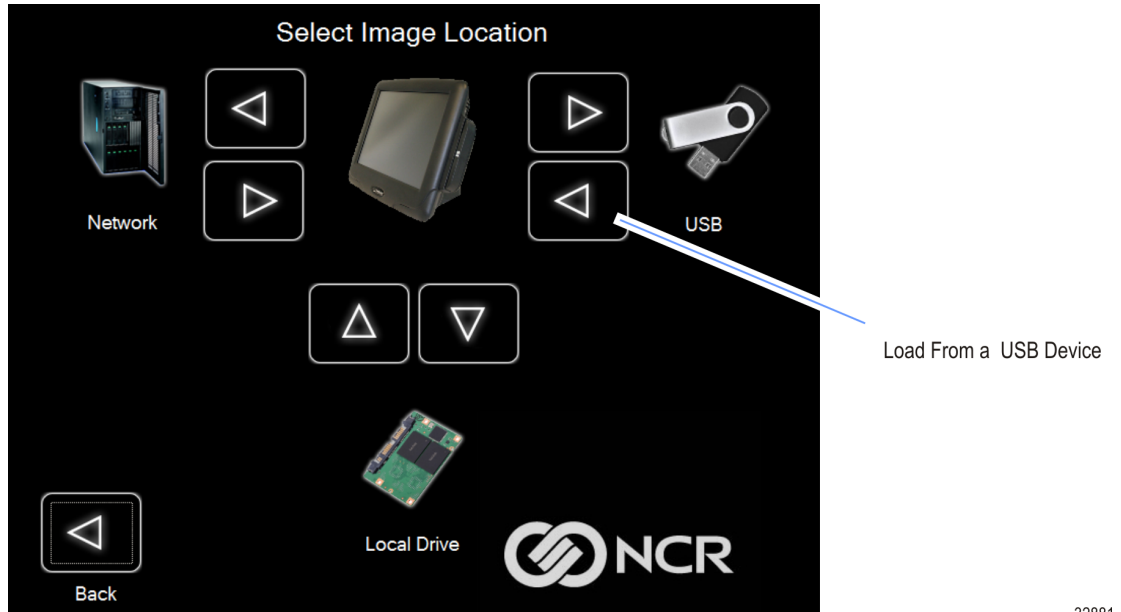

32881

2. Select the **USB Button**.

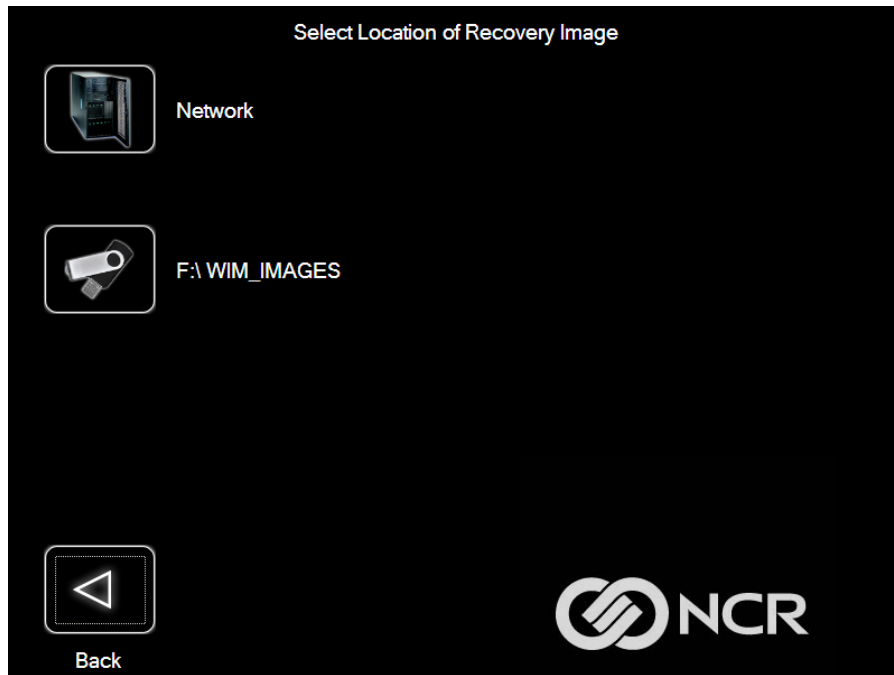

If you are loading from a network, the *Select a Network Drive* dialog screen will open.

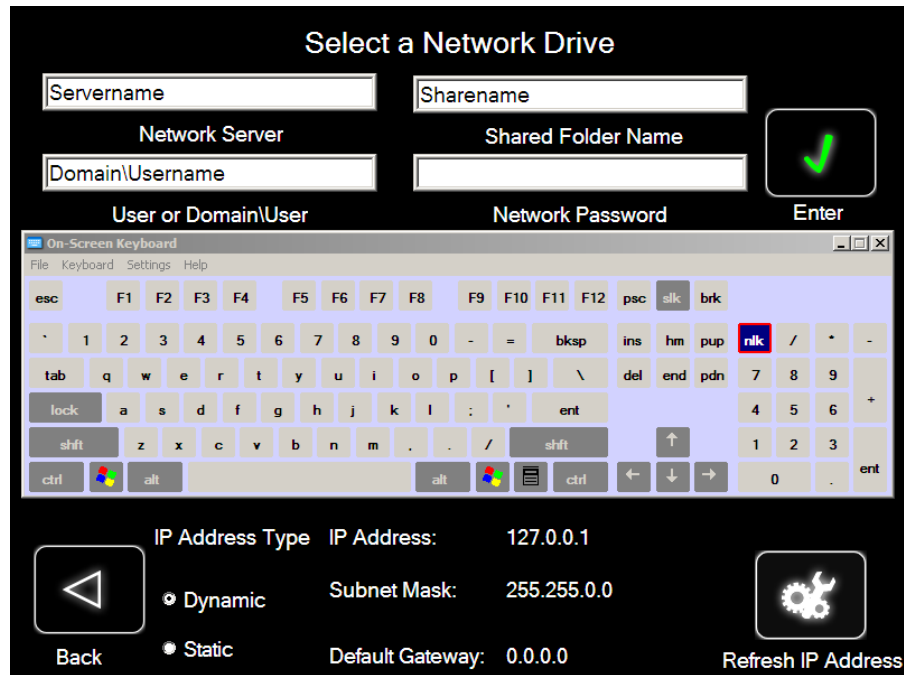

3. Select the *Image Type*.

- **User Image** - Most recent routine backup.
- **Site Image** - Image of the terminal after application components were loaded.
- **Factory Image** - The NCR Base Image as shipped from the factory.

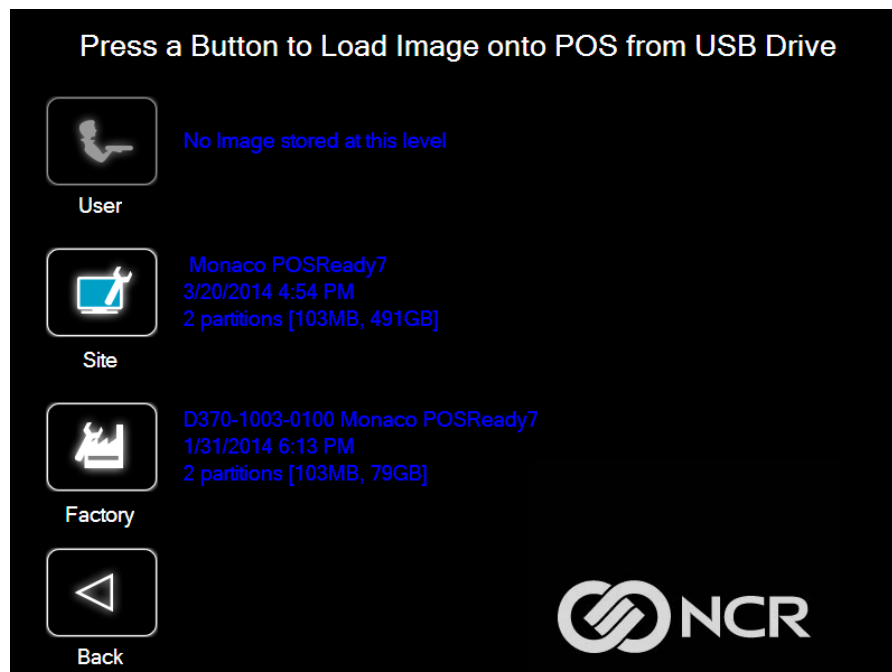

- 4. Select **Yes** to to apply the image.

**⚠ Caution:** All the information in the current productive/working image on the drive is lost with this operation!

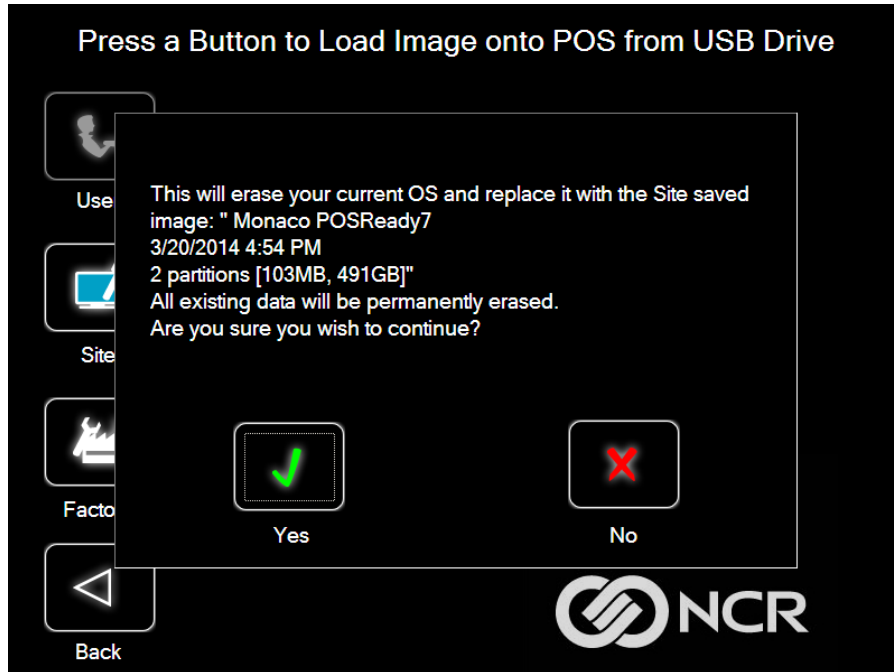

A progress bar is displayed as the image is applied.

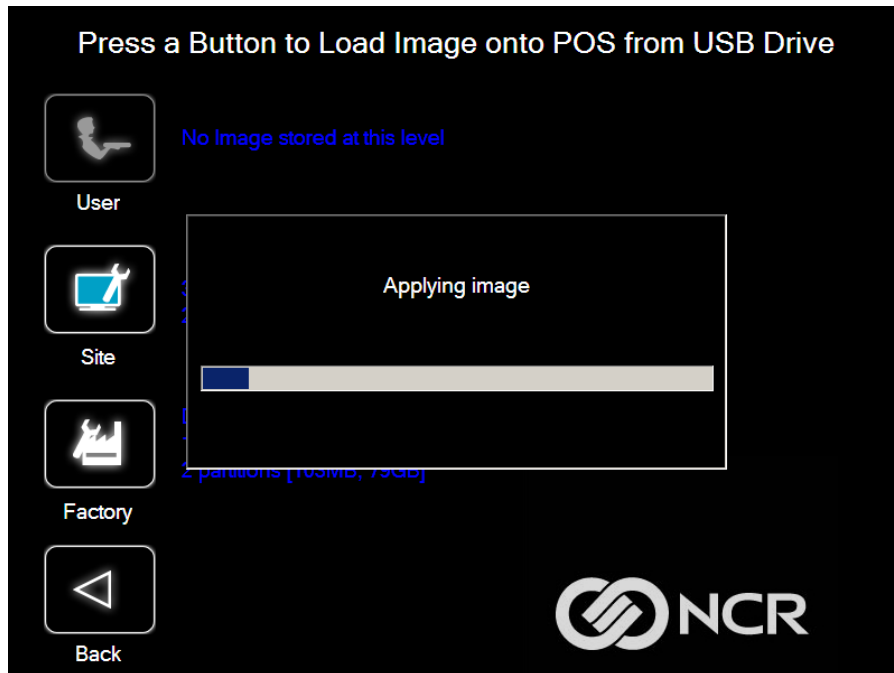

A message is displayed when the load is complete.

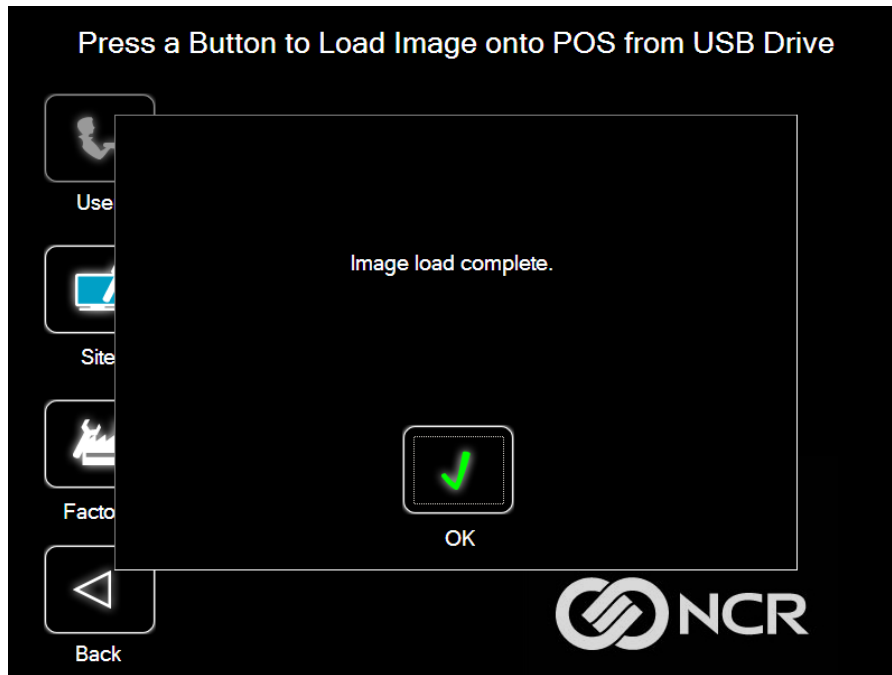

5. **Reboot** the POS.

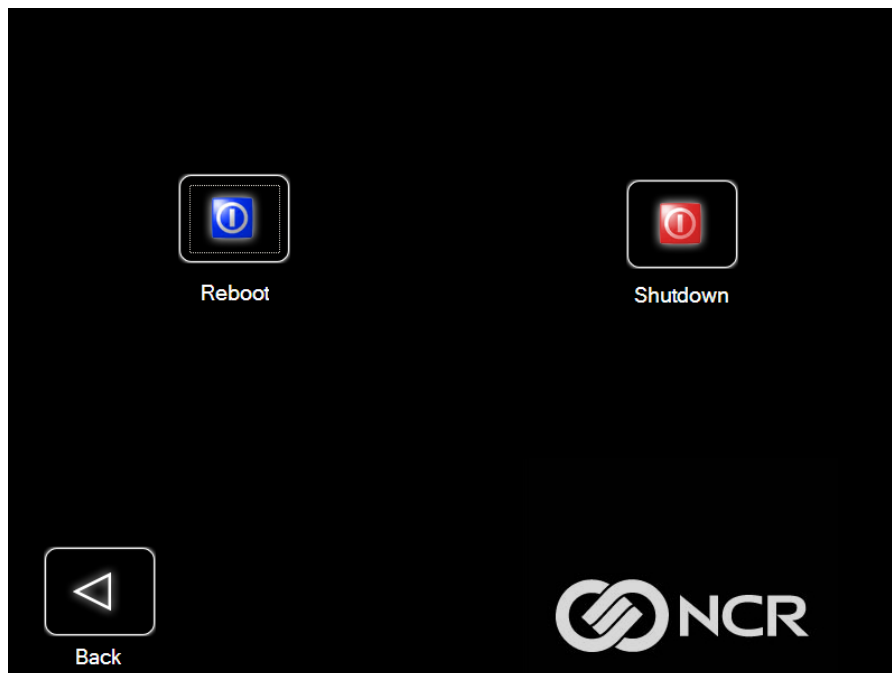

## Change Settings

On the *Main Screen*, Select **Change Settings**.

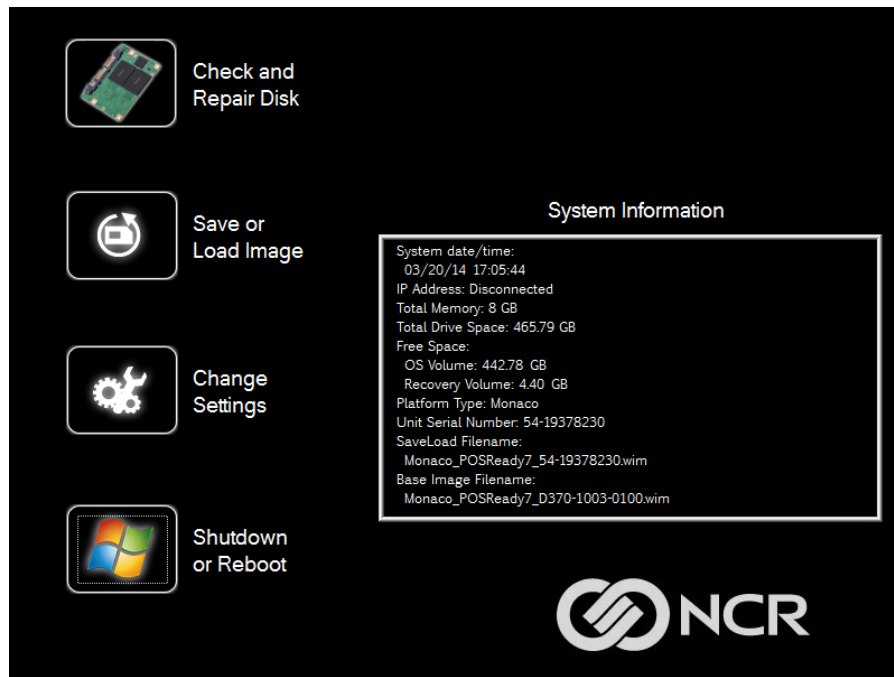

There are four functions available on the *Change Settings* screen.

- Change Network Settings
- Change Password
- Replace Recovery Image
- Change Language



## Change Network Settings

1. On the *Change Settings Screen*, select **Change Network Settings**.

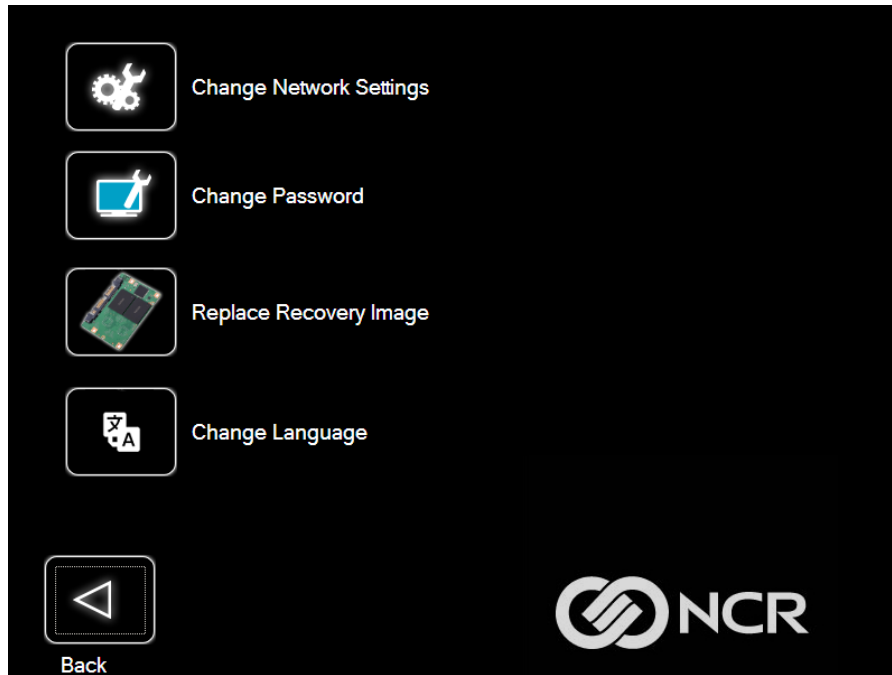

2. Enter the **Password**.

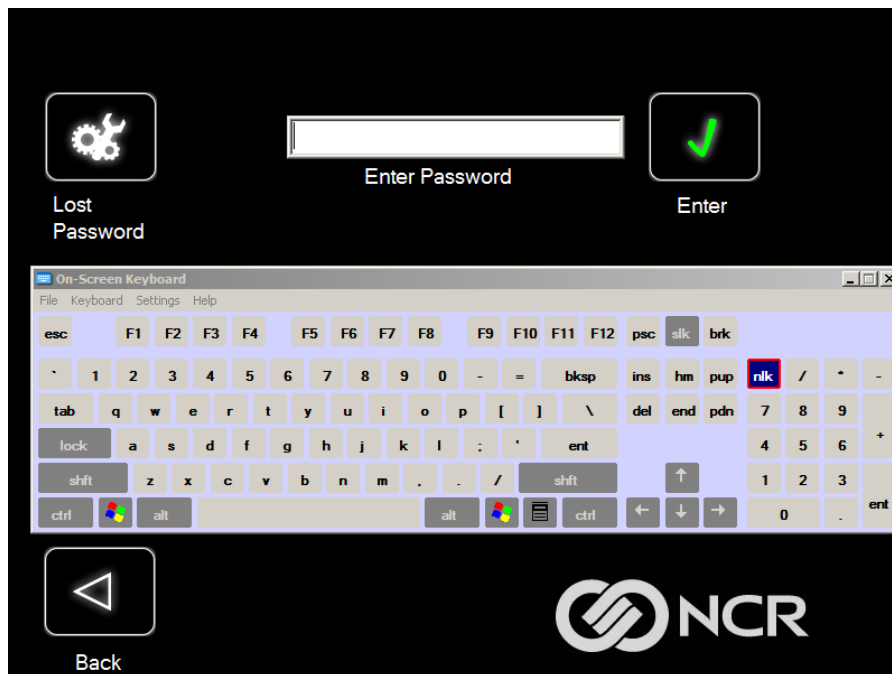

3. Enter the network configuration settings and then select **Enter**.

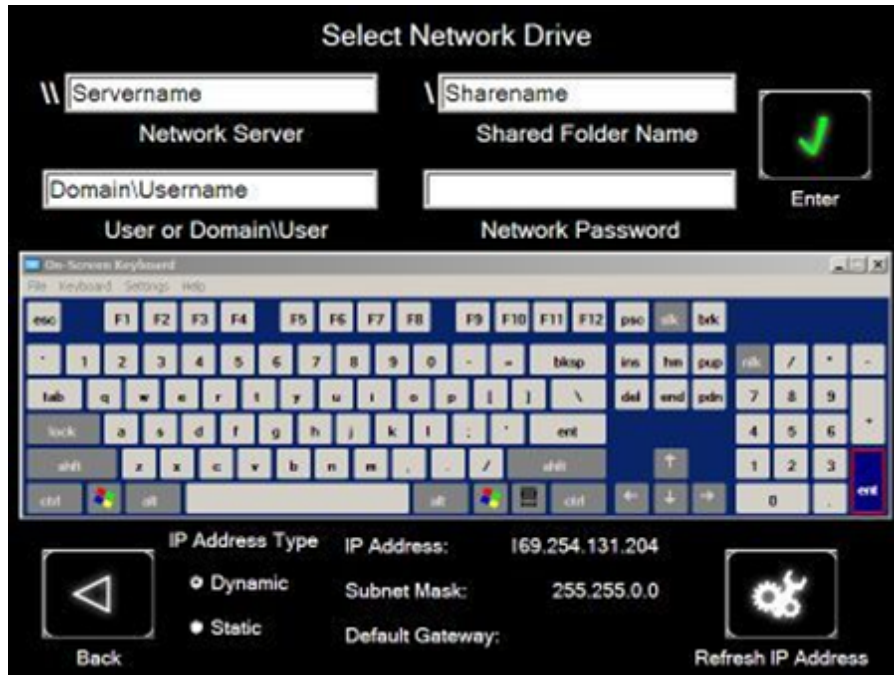

### Change Password

1. On the *Change Settings Screen*, select **Change Password**.
2. Enter the new **Password**. select **Enter**.

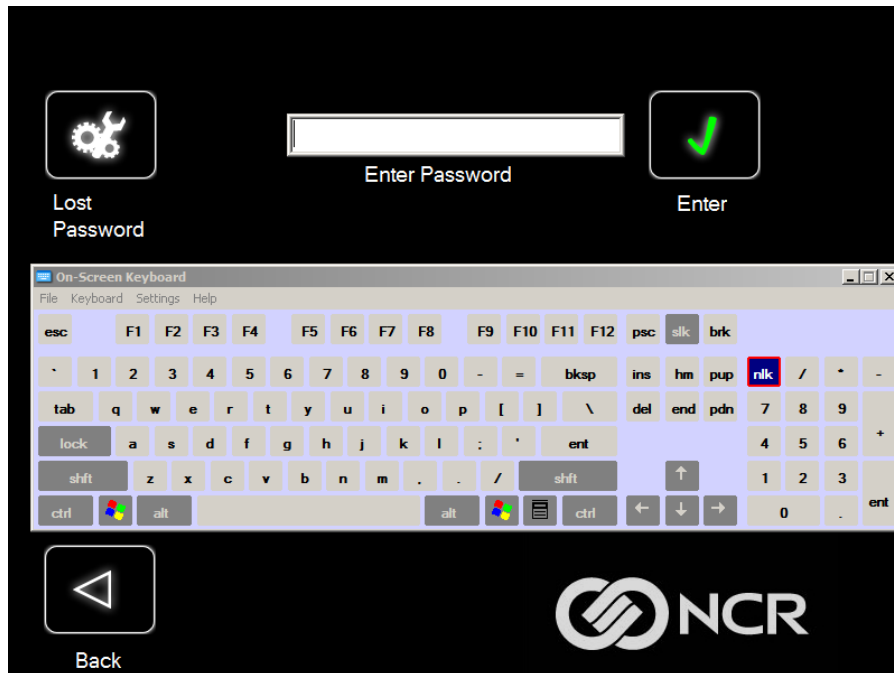

If you have forgotten/lost the password, select Lost Password. A unique code is generated that you can provide to NCR Support to receive a new temporary password.

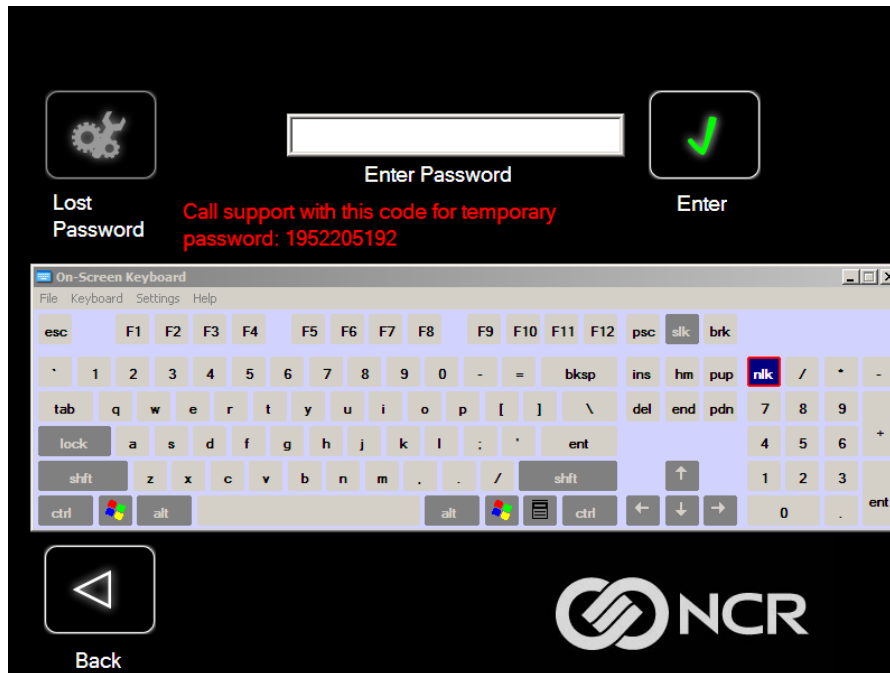

## Replace Recovery Image

This feature is used to update the *Recovery Tool* and the environment that it runs in.

1. On the *Change Settings Screen*, select **Replace Recovery Image**.

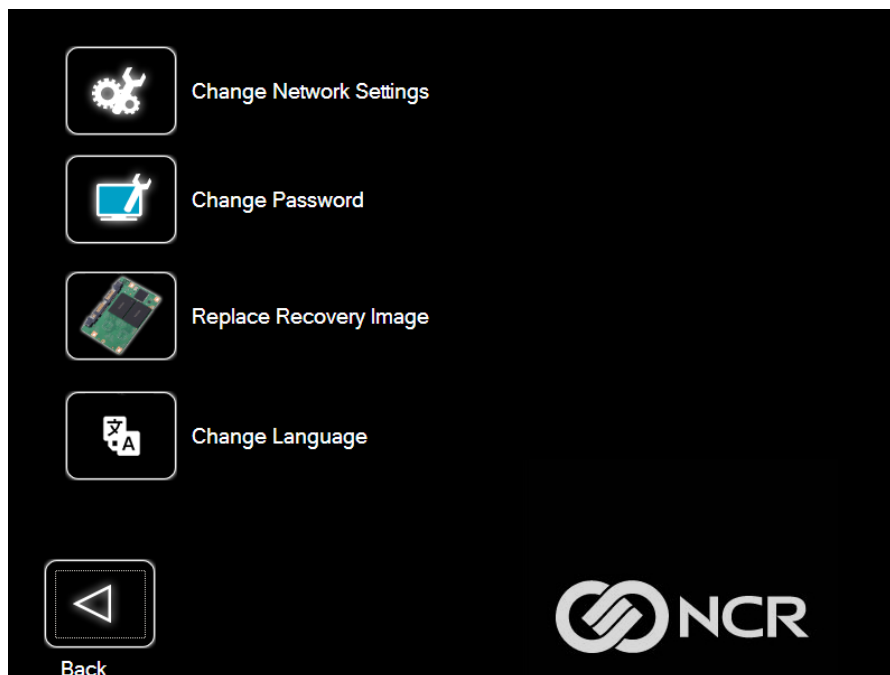

2. Select the source of the *Recovery Image*.

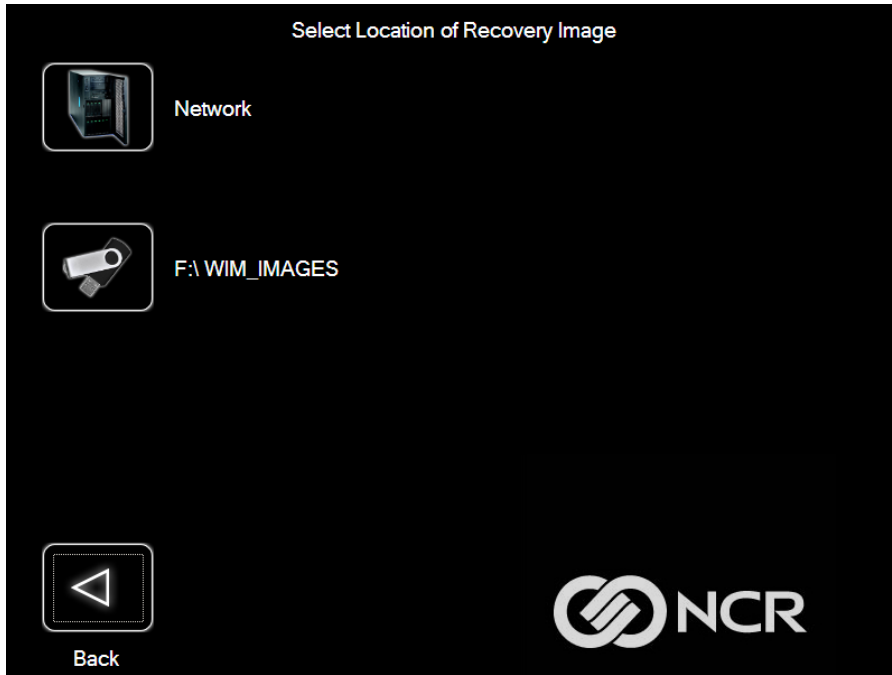

3. Complete the image replacement in the same manner as with the POS *Site/User* image restore procedures.

## Change Language

1. On the *Change Settings Screen*, select **Change Language**



2. Select the language of choice.



## Creating a Disk Image

This terminal has a *Recovery Button* that permits end users to quickly restore a disk backup from a hidden partition on the NCR system storage. To utilize this valuable feature, the image must be created using NCR tools. Tools are available from NCR at:

[https://www5.ncr.com/support/support\\_drivers\\_patches\\_radiant.asp?Class=Hospitality/GenDrivers\\_display](https://www5.ncr.com/support/support_drivers_patches_radiant.asp?Class=Hospitality/GenDrivers_display)

From this site, download the following:

- *ImagingSuite\_3.9.0.3.zip* (or later) - The Imaging Suite package consists of three primary parts:
  - A Server application for local area network imaging
  - A Client application that runs on the target or source machine where images will be applied to or captured from
  - A customized version of Windows PE boot OS environment from which the client application will be run
- [\*Imaging Suite User Guide\*](#) - This document provides a general overview of the Imaging Suite package, how to configure the system to run it, and how to use the applications to capture and apply system images.

---

## Chapter 4: BIOS Setup

---

### Entering Setup

1. Connect a USB alphanumeric keyboard to the terminal.
2. Apply power to the terminal.
3. When you see the NCR logo displayed, select **Del** or **F2**.

### How to Select Menu Options

The following keyboard controls are used to select the menu options and to make changes to their values.

- Use the arrow keys to select (highlight) options and menu screens.
- Use the [**Enter**] key to select a submenu.
- Use the [**+**] and [**-**] keys to change field values.
- To view help information on the possible selections for the highlighted item, select **F1**.
- To save the changes, move the cursor to the *Exit Menu*, select either **Save Changes & Exit** or **Save Changes**, and select **Enter**.

### Restoring Factory Settings

To reset all values to their default settings, select [**F9**] and then [**Enter**] when the confirmation message is displayed. The terminal automatically loads the BIOS default values. To save the factory default values, go to the *Save and Exit Menu*, select **Save Changes & Reset**, and select [**Enter**].



---

# Chapter 5: BIOS Updating Procedure

---

## Introduction

The BIOS is located in the Serial Peripheral Interface (SPI) chip on the processor board. This chapter discusses procedures on how to update the terminal SPI and/or BIOS. The update software is distributed via the NCR Website:

[https://www5.ncr.com/support/support\\_drivers\\_patches.asp](https://www5.ncr.com/support/support_drivers_patches.asp)

The BIOS update can be performed using the following methods:

- Bootable USB Memory Device
- Windows Flash Executable – Requires that the customer has the ability to push the Windows Flash Executable package to each client and then launch the .exe package. After the Flash, the Terminal will reboot automatically.

## Prerequisites

The following are required to perform a SPI/BIOS update.

- USB Alphanumeric Keyboard
- BIOS Software. [Download from the NCR website.](#)
  1. Select the corresponding options for the device/terminal.

**Example: Retail Support Files (Drivers, Firmware, Operating Systems, Platform Software (OPOS/JavaPOS), BIOS, etc.)>>NCR POS and SelfServ Terminal and Operating Systems >>NCR PX10 POS (7746-xxxx) >> BIOS.**

2. Select the desired BIOS File.

### USB Memory Key update prerequisites

- A FAT32 formatted USB Memory Key with sufficient space for the update files.
- Access to a USB port on the terminal to be updated that is enabled in the BIOS (via BIOS setup).

### Windows Flash Executable update prerequisites

- There should be no other programs running while the BIOS/SPI is updating.
- The Windows flash executable is designed to run from an Administrator account.



## SPI/BIOS Updating Procedures

When replacing a 7746 Motherboard in the field, the BIOS will need to be flashed to the latest version based on the OS Platform running on the Terminal (Windows or Android).

### Using the bootable USB Memory key

1. Unzip the USB BIOS files to the root of the USB drive.



**Note:** Ensure the subdirectory structures are intact.

2. Place the BIOS/SPI Update USB Key in an available and enabled USB port.
3. Validate that the BIOS configuration setup has the USB Key as the first boot device in the Boot menu, or use the **F8** BBS menu to force the USB key to be booted.
4. Reboot the system. Use the **F8** key to force booting from the USB key. The flash process will automatically begin.
5. Once the update is complete, a key press will initiate a reboot. The reboot is important to ensure the BIOS initializes properly. Do not interrupt the reboot process.



**Note:** After the update has completed and the terminal is rebooted, the terminal may reboot additional times as it powers up. This is normal and expected behavior due to the nature of the features of the BIOS/SPI.

### Using the Window Flash executable

1. Close all running programs prior to updating the BIOS.
2. To run the executable, right-click on the file and select **Run as administrator**.
3. The user will be prompted to press a key to initiate the flash update.
4. The terminal will reboot after the flash process has completed. The reboot is important to ensure the BIOS initializes properly. Do not interrupt the reboot process.

## Using the Unattended Windows Flash method

This method requires no user input to initiate the flash.

1. Open a Command Prompt window and navigate to the directory where the windows executable is located.
2. Type in the name of the file followed by `/reboot`.

**Example:** `Flash_PX10_1091.exe /reboot`

The BIOS will automatically begin updating.

3. The BIOS will reboot upon completion. The reboot is important to ensure the BIOS initializes properly. Do not interrupt the reboot process.



**Note:** After the update has completed and the terminal is rebooted, the terminal may reboot additional times as it powers up. This is normal and expected behavior due to the nature of the features of the BIOS/SPI.



---

## Chapter 6: Terminal Imaging

---

### Initial Terminal Imaging

Factory default HDD/SSD images for the NCR PX10/PX15 POS (7746) are distributed on bootable auto-imaging USB Flash Drive media. The following procedures describe how to apply/restore an image on the terminal.



**Warning:** Using this procedure will replace any previously stored OS images created using the *Disk Image Backup and Recovery Tool*.



**Note:** A USB Alphanumeric Keyboard is required to perform this operation.

### Imaging Procedure

1. Connect the USB flash drive to the target terminal that you wish to image.
2. Connect a USB alphanumeric keyboard to the terminal.
3. Power on the terminal and boot from the USB Flash Drive. This can be done by selecting **F8** during the boot and choosing the USB option (**NCR**), or by entering *BIOS Setup* and changing the boot order.
4. The system boots in the Windows PE OS environment. Select **Y** on the keyboard at the confirmation prompt to re-image the terminal.
5. When the imaging process is complete, enter **Exit** on the keyboard to reboot the system.
6. After the reboot, remove the USB Flash Drive and disconnect the keyboard.



---

## Chapter 7: **Cleaning**

---

### Cleaning the Touchscreen

Touchscreens can be effectively cleaned with diluted detergent or up to 70% isopropyl alcohol solution. Follow these steps to avoid damage to the touchscreen:

 **Warning: Do not use sharp objects to clean around the edges of the touchscreen. Do not use abrasive cleaners (powders) or abrasive cleaning materials (scrub brush, scouring pad).**

1. Clean the screen using a non-abrasive cloth (microfiber cleaning cloth or cloth towel) and a diluted detergent solution, such as household soap and water.

 **Warning: Do not apply any cleaning products directly to the screen. Do not soak the cloth: wring it out before use.**

2. Dry the screen with another soft cloth.
3. Clean the screen further using a cloth dampened with isopropyl alcohol solution, or using pre-packaged wipes.

 **Warning: Do not apply any cleaning products directly to the screen. Do not soak the cloth: wring it out before use.**

4. Ensure the glass and screen edges are completely dry before using the unit.

## Cleaning the Cabinet

1. Disconnect the unit from the power outlet before cleaning.
2. Wipe the cabinet using a non-abrasive cloth (microfiber cleaning cloth or cloth towel) dampened with soap and water solution.

 **Warning:** Do not use alcohol (methyl, ethyl, or isopropyl) or any strong solvent. Do not use thinner or benzene, abrasive cleaners (powders), abrasive cleaning materials (scrub brush, scouring pad), or compressed air. Do not use any other types of cleaners such as vinegar, solvents, degreasers, or ammonia-based cleaners. These can damage the unit.

 **Warning:** Avoid getting liquids inside the unit. If liquid does get inside, have a qualified service technician check it before you power it on again.

3. Wipe the cabinet using a clean and dry lint-free cloth.
4. Remove external dust around the cooling vents.